

PRODUCT DETAILS

The junction boxes, designed by l'ombre, stylish shape. The device is handmade and consist of brass, this robust material will make the lifespan of the appliance longer. The dark bronze finish of the luminaire exudes craftsmanship and it creates an unique atmosphere in the house.

SPECIFICATIONS

PRODUCT CODE	LENGTH	WIDTH	HEIGHT	WEIGHT	MATERIAL	FINISH
BOX-57-P-7000-GRIP-DB	70mm	70mm	23mm	0,096 kg	Brass	Dark bronze

INSIDE THE BOX: WHAT'S INCLUDED



2x



1x



2x

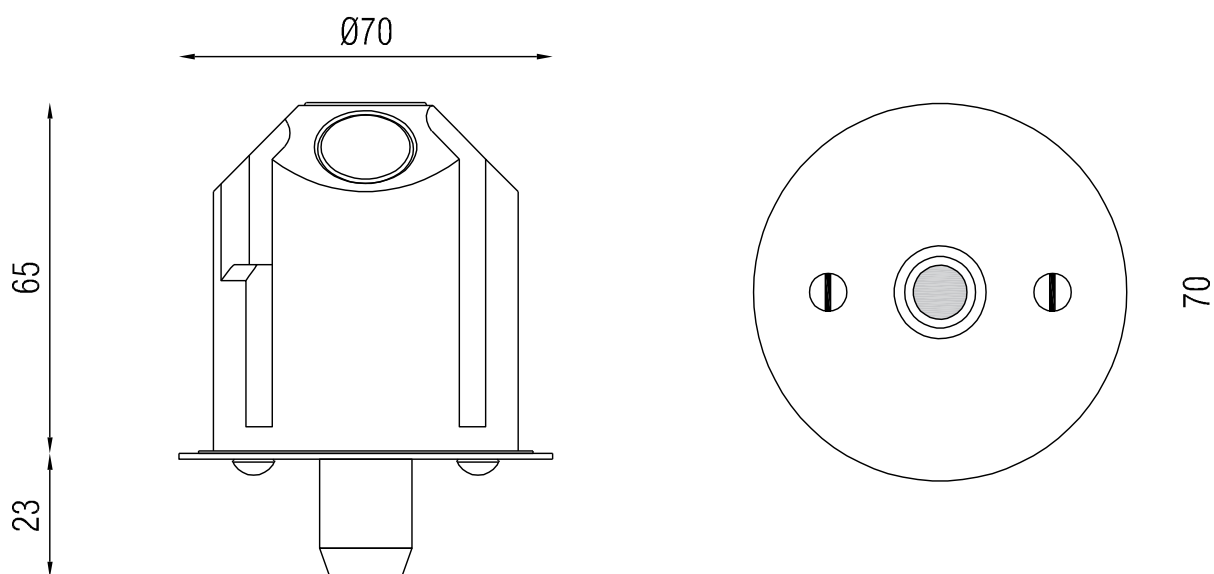

INSTALLATION GUIDE

These instructions are made for your safety. Please read them entirely before starting with the installation of the appliance.

This product may only be installed by an authorised electrical installer.

Make sure there are no other cables close by the place of the power cables.

Ensure to switch OFF the fuse before the installation

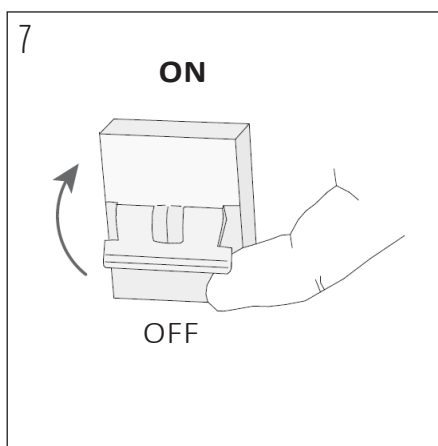
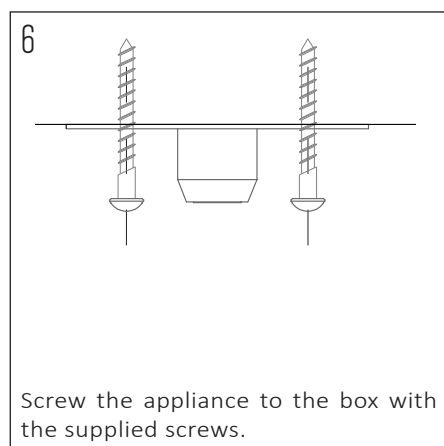
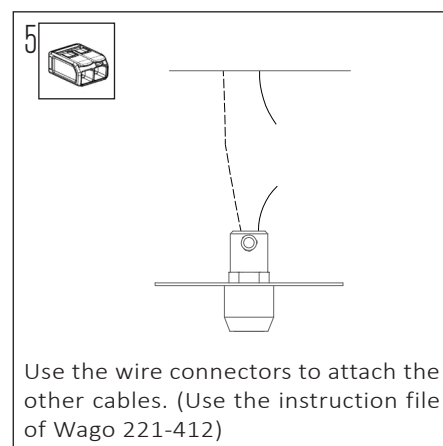
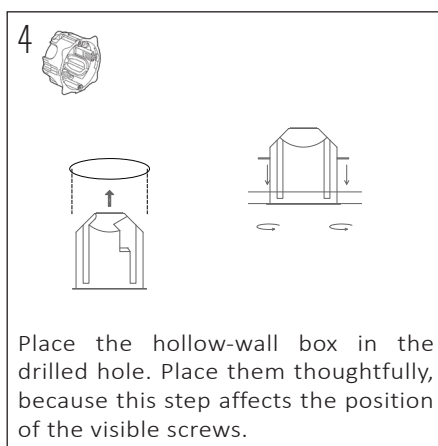
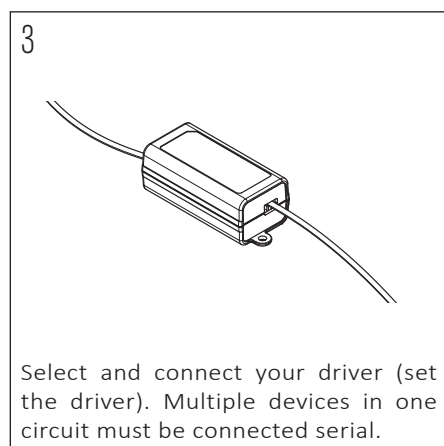
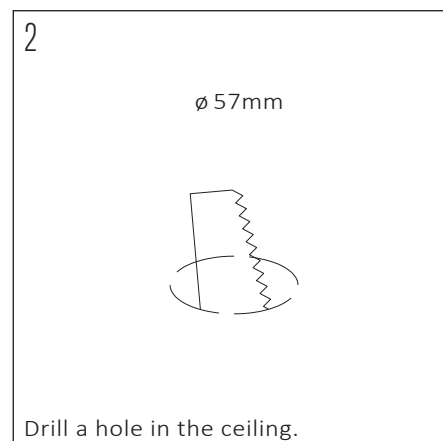
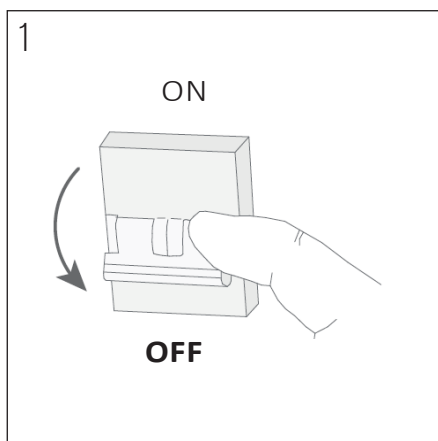

Be sure the installation is done right before switching ON the fuse.

The appliance is ready for use, enjoy the light.

OTHER IMPORTANT INFORMATION

The warranty is invalidated when the device is opened. The lamp in the appliance must only be changed by the manufacturer. Children should be discouraged from playing with the lights. Mount the appliance on dry surfaces, otherwise it may cause discolouration of the finish. Metal finishes should only be cleaned with a soft, dry cloth. Do not use polishes or abrasives. Keep this installation sheet for future uses.

Gebruiksaanwijzingen

Conductor termination

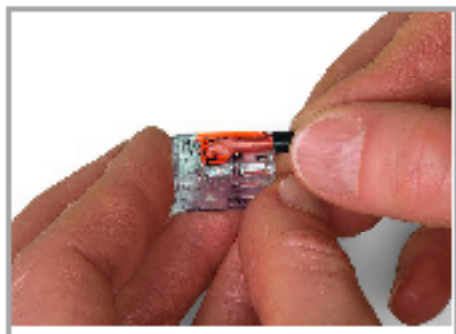

Strip conductor to 11 mm (0.43 inch).

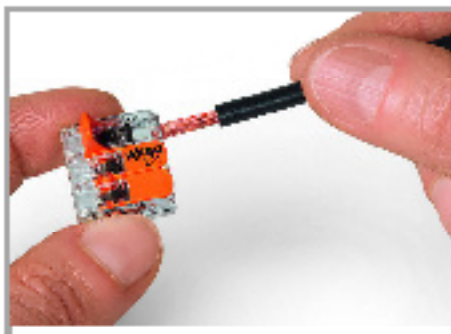

Termination: Lift the lever to open the clamping unit and insert a stripped conductor.

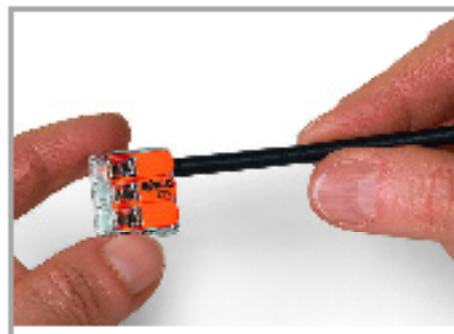

Then, lower the lever to close the clamp.

Application

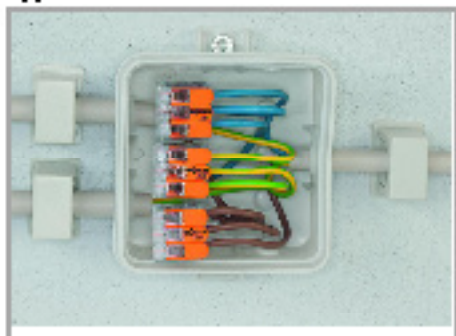

Wiring fine-stranded conductors in a junction box.



Custom low-voltage lighting system



Lighting distribution in ceiling canopy



Pendant light connection in suspended ceilings

Wijzigingen voorbehouden. Let ook op de verdere productdocumentatie!

WAGO Belux nv
Excelsiorlaan 11
1950 Zaventem
Telefoon: +32 (0)2 717 90 90 | Fax: +32 (0)2 717 90 99
E-mail: info-be@wago.com | Web: www.wago.be

Hebt u vragen over onze producten?
U kunt ons telefonisch bereiken op het nr. +32 (0) 2 71 79 090.