

cold stretch ceiling ring Ø38

installation instruction

1

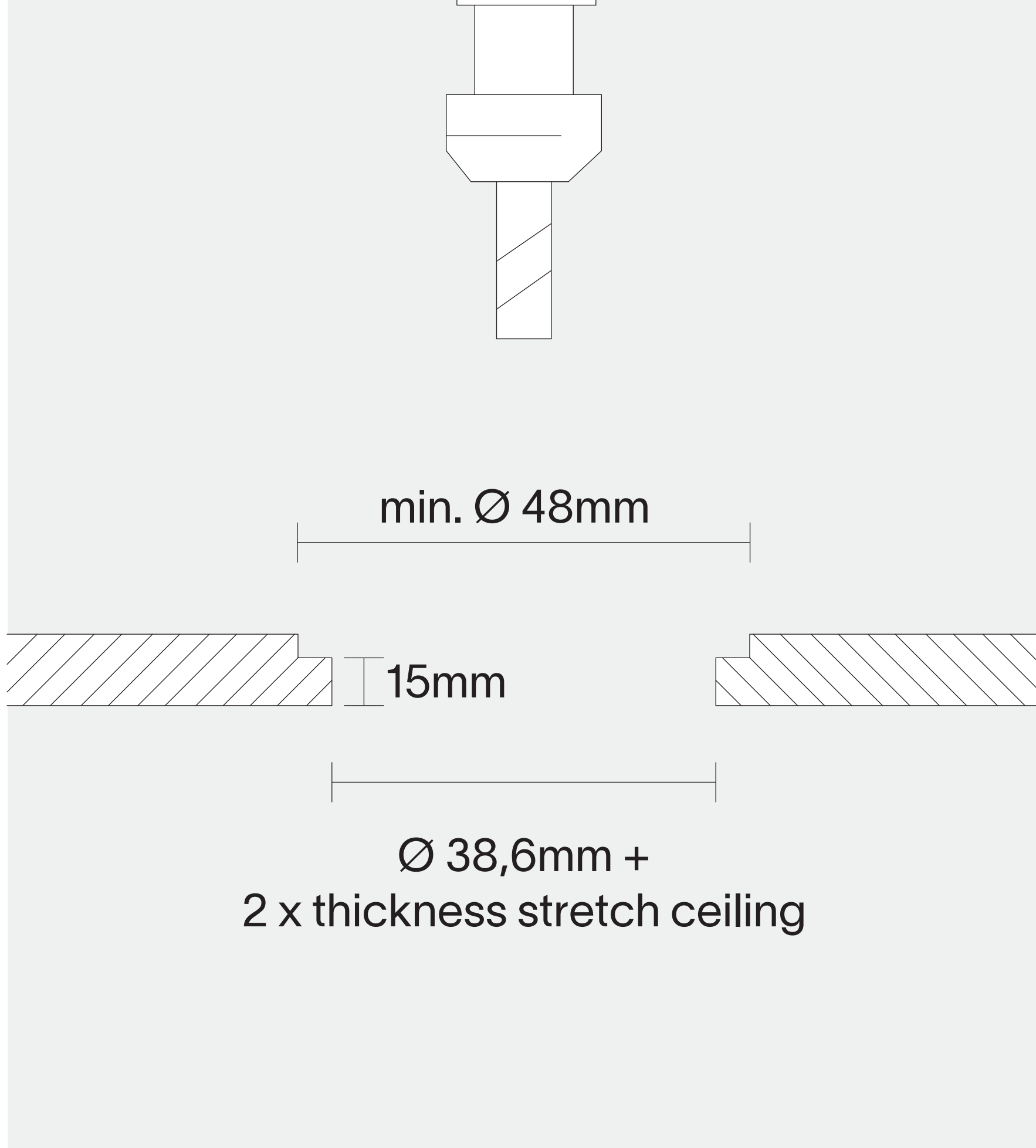

mill a hole with the above dimensions in a wooden base (not supplied) (maximal fabric thickness : 1.2mm)

2

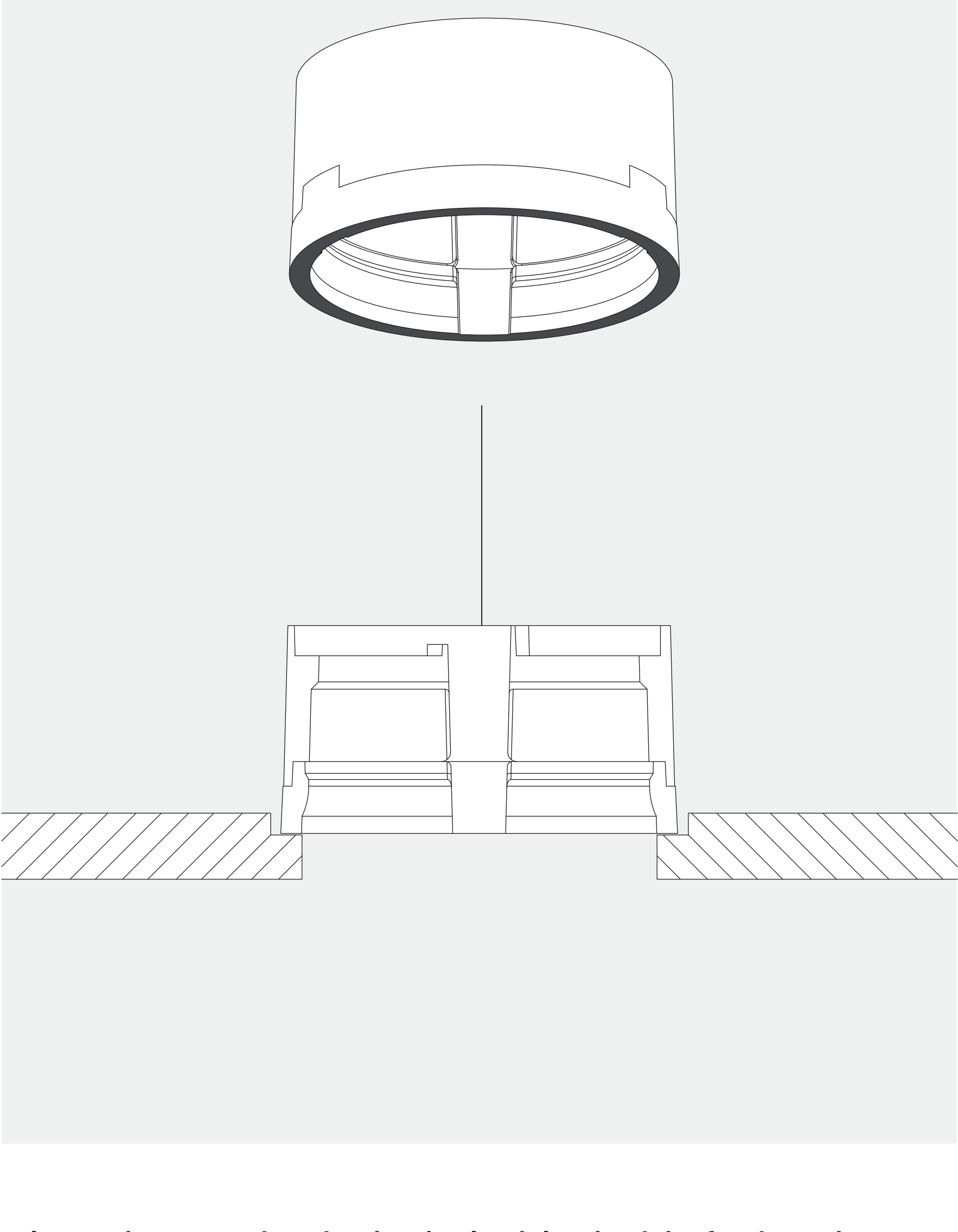

place the csc ring in the hole, black side facing down

3

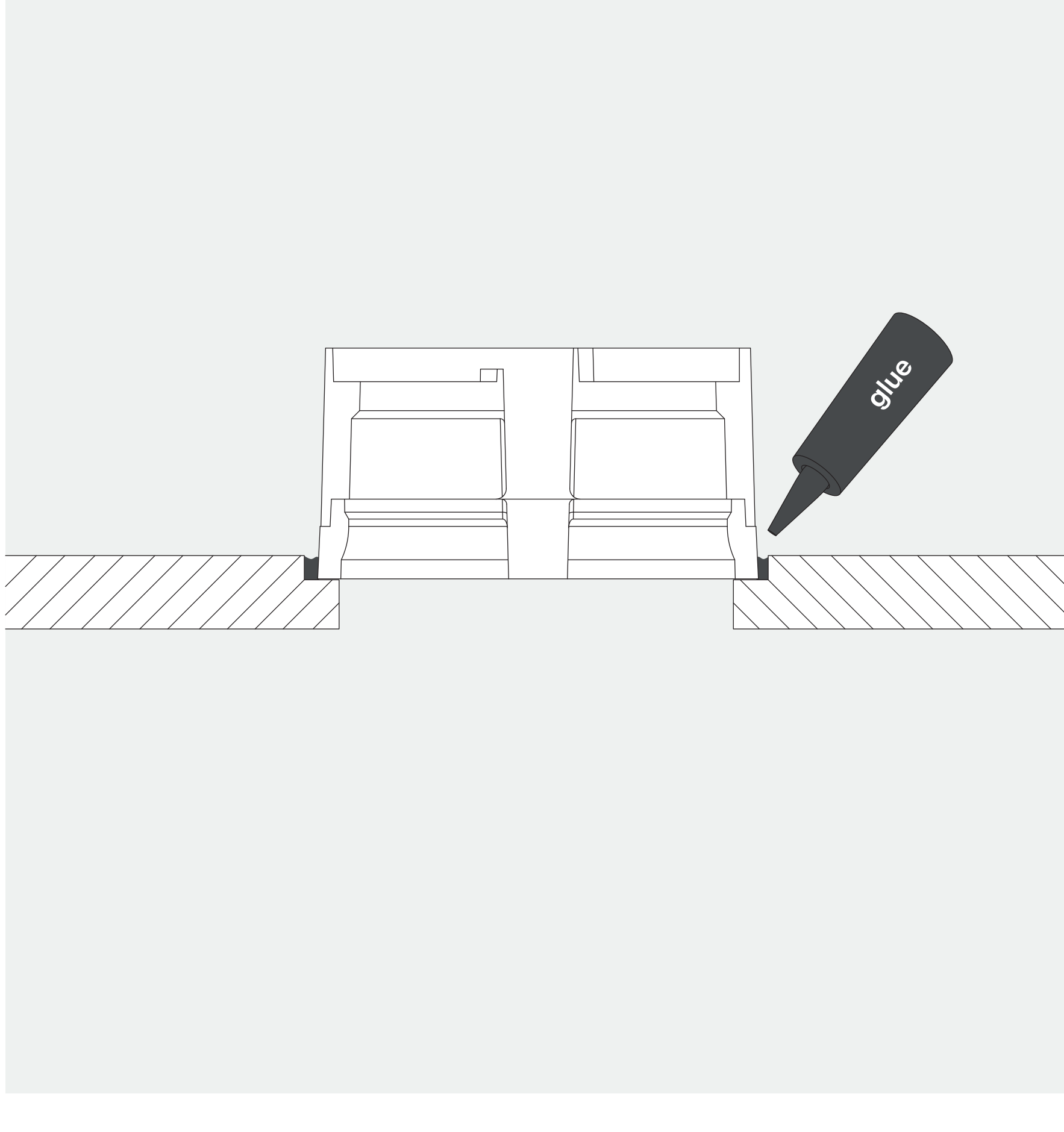

fix the csc ring to the wooden base with the right glue

4



fasten the cloth in the wooden base (below the csc kit)

cut off the excess fabric (it cannot touch the csc ring)

5

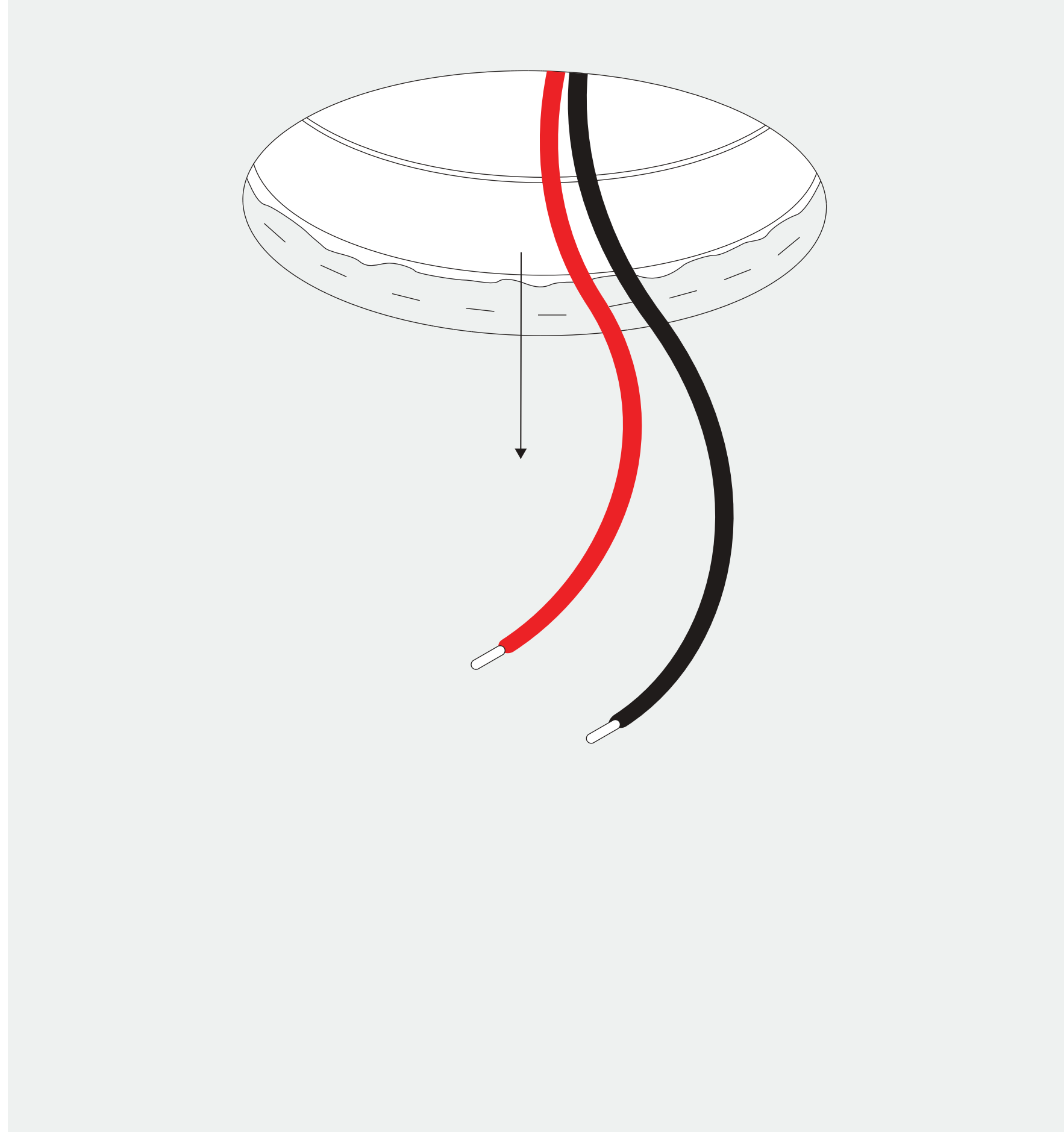

the fixture can now be installed

thank you for choosing prado