

batoc®

Design Lamps



# Catalogue

**betec**<sup>®</sup> Lighting AG

Felix-Wankel-Str. 10

85221 Dachau

Germany

Email: [info@betec.de](mailto:info@betec.de)

Phone: +49(0)8131 292656

Telefax: +49(0)8131 292651

Web: [www.betec.de](http://www.betec.de)

# Lighting Manufacturer

True to its company slogan – Light for the Future ® – betec has enjoyed an excellent international reputation as an innovative lamp manufacturer for 42 years.

Its founder and chief designer Horst Lettenmayer, as chairman of the board, is leading the company together with his successor, Ms Julia-Alina Lettenmayer, as a board member, into a new age of lighting. The early and forward-looking decision not to follow the universal trend, but rather individual demands for design and technology was the basis for the success that continues to this day. The wide variety of different designer lamps, each dominating in its respective technological content, was obvious right from the first very product following the company's foundation. The "Clarus" painting lamp was a revolution in lighting in a minimalist guise. It is already a cult product and has received the German Art Protection award (Deutscher Kunstschutz) as well as prestigious international design awards.

Further developments focused on lighting for living spaces, offices and bathrooms, as well as light to showcase architecture. This resulted in lamps to brighten all these areas. Our efforts to carry on producing lamps as individual hand-crafted pieces, to take the customer's personal wishes into account and to use carefully selected materials runs counter to the current trend of quantity before quality.



Julia-Alina und Horst Lettenmayer



# Quality

All of our lamp models' components are produced in our factory from brass using traditional armory metalworking. This is done with meticulous craftsmanship, from the selection of the raw materials to their processing right down to the surface treatment. To top it off, each component then receives its own colour treatment. Galvanic processes are carried out in a plant for medical instruments, and all varnishes are hand-varnished and baked at 180° C. A timeless design should also be timeless in its durability.

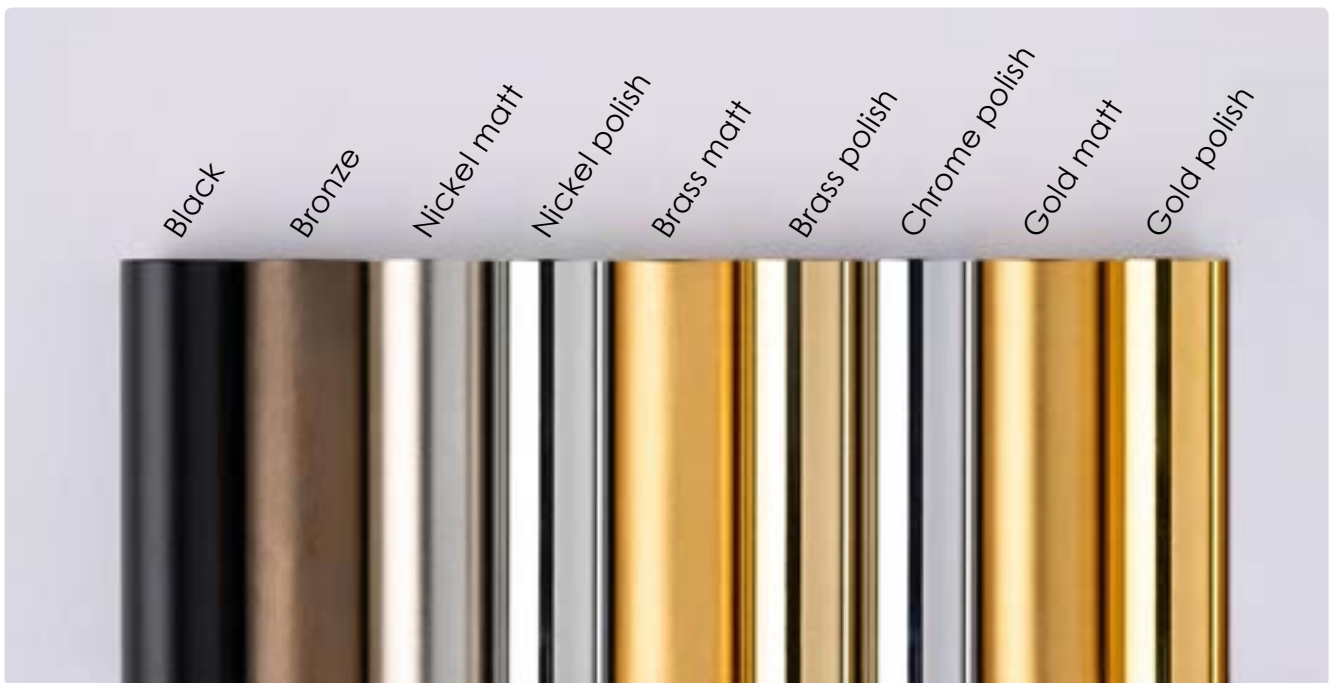

Other colors on request.

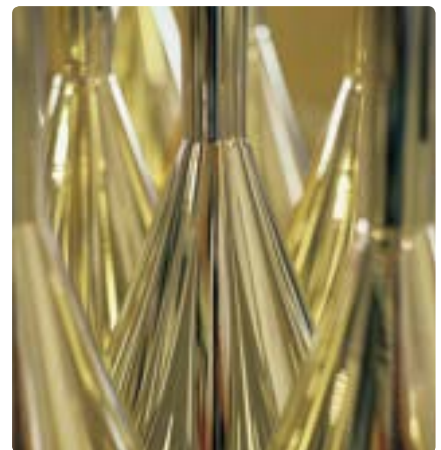

# Design

Those who buy with design in mind are often disappointed by the function that results. Our lights come from a single source. Hence our 42-year success in form and design. Even lights show their age. While the design remains unchanged, the technology of operational reliability is changing at an ever-increasing pace.

As a lighting manufacturer, we are also responsible for the reliable manual selection and processing of appropriate materials using the latest technical equipment. This means that every product is made to order.



# Safety

Our home should be a place of comfort, somewhere we can relax and feel safe. A room's lighting plays a crucial role in achieving this, because it's the lighting that sets the right atmosphere. Accordingly, it ought to be matched to the relevant function. When choosing illumination, you ought to pay attention to the stated colour temperature.

Production safety in use has been tested, and confirmed by the appropriate bodies. Of course, user safety presumes proper handling. An interior light is not designed for – and so must not be used for – outdoor applications. Our lights are only to be connected by qualified professionals. As a manufacturer, however, the safety of our employees is also extremely important to us, so that they can continue to produce reliable lights. There can be no sustainability without safety, in the end. This starts in the manufacturing process with energy, through the complete avoidance of chemical agents and the application of safety measures on processing machinery, all the way to the handling of packaging material. This makes betec lights highly sustainable.



Energy efficiency label as of 2022

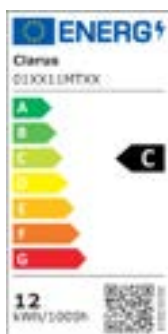

Ingress protection **IP20 IP68** 

Harmonised standards **CE**

Fire safety signs 

Disposal  



# Index

Page	Picture lights
10 - 13	01 Clarus
14 - 17	04 Angulus
18 - 21	07 Minimus
22 - 23	07 Minimus Mono
24 - 27	17 Maximus

	Desk light
28 - 29	03 Ductus

	Music lighting
30 - 31	33 Piano

	Galerie-System
32 - 33	27 Galerie-Stromschiene

	Table lamps
34 - 35	32 Noctis
36 - 37	05 Acus Office
38 - 39	11 Centre où
40 - 41	40 Studeo
42 - 43	26 Cappello Leuchtschirm

	Floor lamps
44 - 45	05 Acus
46 - 47	11 Obelisk 1900
48 - 49	10 Luxus



# Index

Page	<b>Ceiling and wall lights</b>
50 - 51	25 Filum
52 - 53	12 Hamus
54 - 55	30 Folium
56 - 57	09 Palus
58 - 59	14 Oyster
60 - 61	10 Luxus
62 - 63	28 Cubus

	<b>Shelf lights</b>
64 - 65	15 Etagere
66 - 67	15 Vestiaire

	<b>Mirror lights</b>
68 - 69	06 Magnus
70 - 71	06 Make up 3
72 - 73	06 Make up 5
74 - 75	06 Make up 6
76 - 77	06 Make up 7
78 - 79	06 Make up 8
80 - 81	06 Make up 10 Discus

	<b>Pool spot</b>
82 - 83	22 Disque

	<b>Track systems</b>
84 - 85	16 Planus
86 - 89	19 Galaxis-System

90	<b>Clarus conversion to LED</b>
91	<b>Electronic components</b>
92 - 96	Special lights
97 - 98	Terms and conditions

# 01 Clarus®

The latest advances in lighting technology right now are characterised by LED lamps. Our picture light is equipped with 3000 Kelvin as standard. The highly constant light output alongside low power consumption and an extremely long lifespan are ideal conditions for modern picture lighting.

Application: lighting pictures, menus and music stands.

Material: brass, illuminant: single LED, LED-CEE: C, Ra: 90, ballast unit 20W: 107 x 41 x 22 mm, primary voltage: 220-240V, secondary voltage: DC 24V, rotatable fluorescent tube: Ø 14 mm, bracket tube: Ø 6 mm

Scope of delivery: whole lamp with illuminant, mounting set and a dimmable ballast unit.

**IP20**



**CE**

Design: Horst Lettenmayer © betec

Colour	Article number
Brass polished	01 <b>MO</b> -- -- --
Brass mat	01 <b>MM</b> -- -- --
Chrome	01 <b>CO</b> -- -- --
Nickel polished	01 <b>NO</b> -- -- --
Nickel mat	01 <b>NM</b> -- -- --
Brown	01 <b>BO</b> -- -- --
Black mat	01 <b>SM</b> -- -- --
Gold 24ct polished	01 <b>GO</b> -- -- --
Gold 24ct mat	01 <b>GM</b> -- -- --

Colour	Length	Light output	Article number
Brass	<b>160</b> mm	0,6 Watt	01 MO <b>01</b> -- --
Brass	<b>260</b> mm	1,8 Watt	01 MO <b>02</b> -- --
Brass	<b>360</b> mm	3,0 Watt	01 MO <b>03</b> -- --
Brass	<b>460</b> mm	4,2 Watt	01 MO <b>04</b> -- --
Brass	<b>560</b> mm	5,4 Watt	01 MO <b>05</b> -- --
Brass	<b>660</b> mm	6,6 Watt	01 MO <b>06</b> -- --
Brass	<b>760</b> mm	7,8 Watt	01 MO <b>07</b> -- --
Brass	<b>860</b> mm	9,0 Watt	01 MO <b>08</b> -- --
Brass	<b>960</b> mm	10,2 Watt	01 MO <b>09</b> -- --
Brass	<b>1060</b> mm	11,4 Watt	01 MO <b>10</b> -- --
Brass	<b>1160</b> mm	12,6 Watt	01 MO <b>11</b> -- --

LED Mono + Light colour: -- -- -- **M** - --

2400K	Warm tone	RA 80+/ 750Lm/m	01 -- -- <b>MW</b> --
2700K	Neutral	RA 90+/ 1640Lm/m	01 -- -- <b>MN</b> --
3000K	Daylight	RA 90+/ 750Lm/m	01 -- -- <b>MT</b> --



Arm Type

Width

Article number

Type **11**

110 mm

01 -- -- -- **11**

Type **17**

170 mm

01 -- -- -- **17**

Type **22**

220 mm

01 -- -- -- **22**

Coupling arm



11 cm

**Type 11**



17 cm

**Type 17**

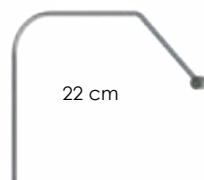

22 cm

**Type 22**



For each type

**Coupling arm**

Special option touch dimmer

Article number



50TD01LD24





# 04 Angulus

A novelty in our range of lamps is the "Angulus" picture light. The angular shape of the light fits in more harmoniously with corresponding picture frames. As with all our picture lamps, the lighting profile can be rotated in order to have the optimal light level set. This lamp has a duo LED illuminant, which allowed the light output to be doubled. Particularly suitable as display lighting. Application: lighting pictures, menus and music stands.

Material: brass, illuminant: dual LED, LED-EC: F, Ra: 90, ballast unit: 220-240V, secondary voltage: DC 24V, 12W ballast unit: 94 x 36 x 18 mm, 30W ballast unit: 133 x 46 x 24 mm rotatable fluorescent tube: 17 x 17 mm, bracket tube: Ø 8 mm

Scope of delivery: whole lamp with diffuser cover, mounting set and a dimmable ballast unit.

**IP20**



**CE**

Design: Horst Lettenmayer © betec

Colour	Article number
Brass polished	04 <b>MO</b> -- -- --
Brass mat	04 <b>MM</b> -- -- --
Chrome	04 <b>CO</b> -- -- --
Nickel polished	04 <b>NO</b> -- -- --
Nickel mat	04 <b>NM</b> -- -- --
Brown	04 <b>BO</b> -- -- --
Black mat	04 <b>SM</b> -- -- --
Gold 24ct polished	04 <b>GO</b> -- -- --
Gold 24ct mat	04 <b>GM</b> -- -- --

Colour	Length	Light output	Article number
Brass	<b>250</b> mm	6 Watt	04 MO <b>02</b> -- --
Brass	<b>500</b> mm	13 Watt	04 MO <b>05</b> -- --
Brass	<b>750</b> mm	20 Watt	04 MO <b>07</b> -- --
Brass	<b>1000</b> mm	27 Watt	04 MO <b>10</b> -- --

LED Duo + Light colour:			-- -- -- <b>D</b> -- --
2400K	Warm tone	RA 80+/1500lm/m	04 -- -- <b>DW</b> --
2700K	Neutral	RA 90+/3280lm/m	04 -- -- <b>DN</b> --
3000K	Daylight	RA 90+/1500lm/m	04 -- -- <b>DT</b> --



Arm Type	Width	Article number
Type <b>15</b>	150 mm	04 -- -- -- <b>15</b>
Type <b>20</b>	200 mm	04 -- -- -- <b>20</b>
Type <b>25</b>	250 mm	04 -- -- -- <b>25</b>
Coupling arm		

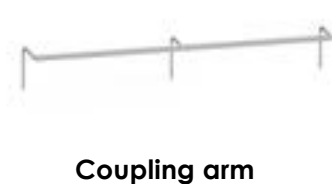
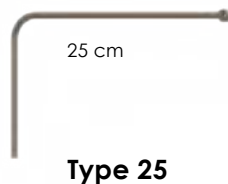
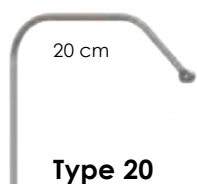

Special option touch dimmer	Article number
-----------------------------	----------------



50TD01LD24







# 07 Minimus

As an extension to our "Clarus" lamp, but with a tube diameter of 18 mm, this lamp was developed for the use of a dual LED unit. The double brightness of the "Minimus" is a decisive factor for choosing this product. As a secondary effect, this painting lamp can also be used to brighten rooms. The output light mainly brightens the object in question, but the inevitable scattered light emitted from the lamp fills the room with a basic level of brightness that is an unperceived requirement for our well-being. Application: picture lighting, menu lighting and music stand lighting.

Material: brass, illuminant: dual LED, LED-CEE: F, Ra: 90, ballast unit: 220-240V, secondary voltage: DC 24V, 12W ballast unit: 94 x 36 x 18 mm, 30W ballast unit: 133 x 46 x 24 mm, rotatable fluorescent tube: Ø 18 mm, bracket tube: Ø 8 mm

Scope of delivery: whole lamp with illuminant, mounting set and a dimmable ballast unit.

**IP20**



**CE**

Design: Horst Lettenmayer © betec

Colour	Article number
Brass polished	07 <b>MO</b> -- -- --
Brass mat	07 <b>MM</b> -- -- --
Chrome	07 <b>CO</b> -- -- --
Nickel polished	07 <b>NO</b> -- -- --
Nickel mat	07 <b>NM</b> -- -- --
Brown	07 <b>BO</b> -- -- --
Black mat	07 <b>SM</b> -- -- --
Gold 24ct polished	07 <b>GO</b> -- -- --
Gold 24ct mat	07 <b>GM</b> -- -- --

Colour	Length	Light output	Article number
Brass	<b>591</b> mm	14 Watt	07 MO <b>06</b> -- --
Brass	<b>891</b> mm	23 Watt	07 MO <b>09</b> -- --
Brass	<b>1191</b> mm	32 Watt	07 MO <b>12</b> -- --

LED Duo + Light colour:			-- -- -- <b>D</b> -- --
2400K	Warm tone	RA 80+/1500Lm/m	07 -- -- <b>DW</b> --
2700K	Neutral	RA 90+/3280Lm/m	07 -- -- <b>DN</b> --
3000K	Daylight	RA 90+/1500Lm/m	07 -- -- <b>DT</b> --



Arm Type	Width	Article number
Type <b>20</b>	200 mm	07 -- -- -- <b>20</b>
Type <b>25</b>	250 mm	07 -- -- -- <b>25</b>
Type <b>28</b>	280 mm	07 -- -- -- <b>28</b>
Type <b>15</b>	150 mm	07 -- -- -- <b>15</b>
Type <b>30</b>	300 mm	07 -- -- -- <b>30</b>
Type <b>10</b>	100 mm	07 -- -- -- <b>10</b>
Coupling arm		

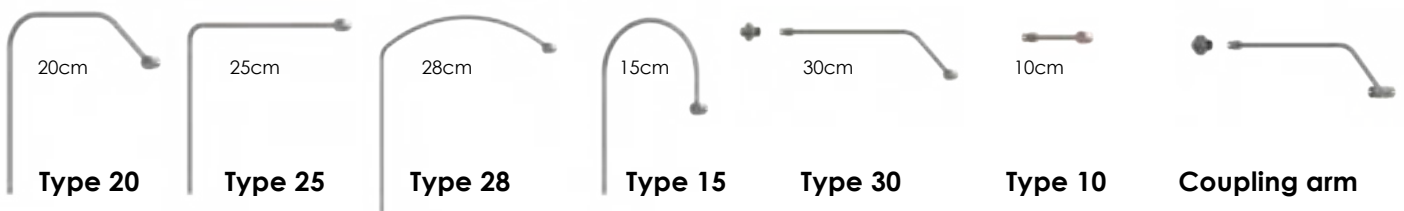

Special option touch dimmer      Article number



50TD01LD24





# 07 Minimus Mono

The LED picture light with a single central bracket is ideal for small pictures or photos. The light output is very high despite its short length. The lamp can either be attached to the back of the picture frame or to the wall. The level of light can be regulated by parallel rotation of the ends of the tubes.

Material: brass, illuminant: Duo LED, LED-CEE: F, Ra: 90, ballast unit: 220-240V, secondary voltage: DC 24V, 12W ballast unit: 94 x 36 x 18 mm, light tube: Ø 18 mm, fluorescent tube: Ø 8 mm

Scope of delivery: whole lamp with LED illuminant, mounting set and a dimmable ballast unit.

**IP20**



**CE**

Design: Horst Lettenmayer © betec

Colour	Article number
Brass polished	07 <b>MO</b> -- -- --
Brass mat	07 <b>MM</b> -- -- --
Chrome	07 <b>CO</b> -- -- --
Nickel polished	07 <b>NO</b> -- -- --
Nickel mat	07 <b>NM</b> -- -- --
Brown	07 <b>BO</b> -- -- --
Black mat	07 <b>SM</b> -- -- --
Gold 24ct polished	07 <b>GO</b> -- -- --
Gold 24ct mat	07 <b>GM</b> -- -- --

Colour	Length	Light output	Article number
Brass	<b>140</b> mm	2,4W / 528 Lm	07 MO <b>01</b> -- --

LED Duo + Light colour:			-- -- -- <b>D</b> --
2400K	Warm tone	RA 80+/1500Lm/m	07 -- -- <b>DW</b> --
2700K	Neutral	RA 90+/3280Lm/m	07 -- -- <b>DN</b> --
3000K	Daylight	RA 90+/1500Lm/m	07 -- -- <b>DT</b> --

Special option touch dimmer	Article number
-----------------------------	----------------



50TD01LD24



# 17 Maximus

In order to illuminate large paintings with strong frames, a correspondingly larger picture light is required to optically balance the picture and the light. This is why the „Maximus“ picture light was created, which can be used for pictures up to several metres wide. Using this lamp as painting or museum lighting also has a secondary effect of brightening the room. The output light mainly brightens the object in question, but the inevitable scattered light emitted from the lamp fills the room with a basic level of brightness that is an unperceived requirement for our well-being. Application: picture lighting, shelf lighting and wall lighting.

Material: brass, illuminant: dual LED, LED-CEE: F, Ra: 90, ballast unit: 220-240V, secondary voltage: DC 24V, rotatable fluorescent tube: Ø 34 mm, bracket tube: Ø 8 mm, ballast unit 12W: 94 x 36 x 18 mm, 30W ballast unit: 133 x 46 x 24 mm

Scope of delivery: whole lamp with illuminant, mounting set and a dimmable ballast unit.

**IP20**



**CE**

Design: Horst Lettenmayer © betec

Colour	Article number
Brass polished	17 <b>MO</b> -- -- --
Brass mat	17 <b>MM</b> -- -- --
Chrome	17 <b>CO</b> -- -- --
Nickel polished	17 <b>NO</b> -- -- --
Nickel mat	17 <b>NM</b> -- -- --
Brown	17 <b>BO</b> -- -- --
Black mat	17 <b>SM</b> -- -- --
Gold 24ct polished	17 <b>GO</b> -- -- --
Gold 24ct mat	17 <b>GM</b> -- -- --

Colour	Length	Light output	Article number
Brass	<b>490</b> mm	12 Watt	17 MO <b>05</b> -- --
Brass	<b>650</b> mm	16 Watt	17 MO <b>06</b> -- --
Brass	<b>770</b> mm	19 Watt	17 MO <b>07</b> -- --
Brass	<b>950</b> mm	24 Watt	17 MO <b>09</b> -- --
Brass	<b>1250</b> mm	33 Watt	17 MO <b>12</b> -- --
Brass	<b>1550</b> mm	42 Watt	17 MO <b>15</b> -- --

LED Duo + Light colour: -- -- -- **D** -- --

2400K	Warm tone	RA 80+/1500Lm/m	17 -- -- <b>DW</b> --
2700K	Neutral	RA 90+/3280Lm/m	17 -- -- <b>DN</b> --
3000K	Daylight	RA 90+/1500Lm/m	17 -- -- <b>DT</b> --





Arm Type	Width	Article number
Type <b>20</b>	200 mm	17 -- -- -- <b>20</b>
Type <b>25</b>	250 mm	17 -- -- -- <b>25</b>
Type <b>30</b>	300 mm	17 -- -- -- <b>30</b>
Type <b>10</b>	100 mm	17 -- -- -- <b>10</b>
Coupling arm		

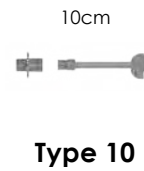
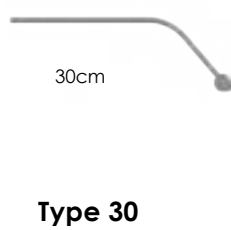
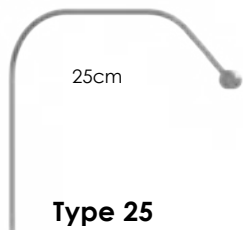
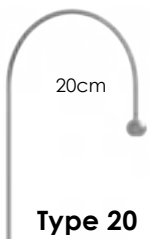

Special option touch dimmer

Article number



50TD01LD24





# 03 Ductus

Lectern, desk or wall lamp with the highest level of precision craftsmanship. Holding brackets come in various shapes and lengths. Either as a plug-in version on lecterns, with mounting collars for installation on walls or for permanent installation on shelves using retaining clamps. Also ideal as a showcase lamp and display panel lighting due to its low current consumption and extremely long service life. Application: picture, menu and desk/lectern lighting.

Material: brass, illuminant: LED, LED-CEE: F, Ra: 90, primary voltage: 220-240V, secondary voltage: DC 24V, 20W ballast unit: 107 x 41 x 22 mm, rotatable fluorescent tube: Ø 14 mm, bracket tube: Ø 6 mm

Scope of delivery: whole lamp with LED illuminant, dimmable ballast unit and threaded sleeve with flange.

**IP20**



**CE**

Design: Horst Lettenmayer © betec

Colour	Article number
Brass polished	03 <b>MO</b> -- -- --
Brass mat	03 <b>MM</b> -- -- --
Chrome	03 <b>CO</b> -- -- --
Nickel polished	03 <b>NO</b> -- -- --
Nickel mat	03 <b>NM</b> -- -- --
Brown	03 <b>BO</b> -- -- --
Black mat	03 <b>SM</b> -- -- --
Gold 24ct polished	03 <b>GO</b> -- -- --
Gold 24ct mat	03 <b>GM</b> -- -- --

Colour	Length	Light output	Article number
Brass	<b>160</b> mm	0,6 Watt	03 MO <b>01</b> -- --
Brass	<b>260</b> mm	1,8 Watt	03 MO <b>02</b> -- --
Brass	<b>360</b> mm	3,0 Watt	03 MO <b>03</b> -- --
Brass	<b>460</b> mm	4,2 Watt	03 MO <b>04</b> -- --
Brass	<b>560</b> mm	5,4 Watt	03 MO <b>05</b> -- --
Brass	<b>660</b> mm	6,6 Watt	03 MO <b>06</b> -- --
Brass	<b>760</b> mm	7,8 Watt	03 MO <b>07</b> -- --
Brass	<b>860</b> mm	9,0 Watt	03 MO <b>08</b> -- --
Brass	<b>960</b> mm	10,2 Watt	03 MO <b>09</b> -- --
Brass	<b>1060</b> mm	11,4 Watt	03 MO <b>10</b> -- --
Brass	<b>1160</b> mm	12,6 Watt	03 MO <b>11</b> -- --

LED Mono + Light colour: -- -- -- **M** -- --

2400K	Warm tone	RA 80+/ 750Lm/m	03 -- -- <b>MW</b> --
2700K	Neutral	RA 90+/ 1640Lm/m	03 -- -- <b>MN</b> --
3000K	Daylight	RA 90+/ 750Lm/m	03 -- -- <b>MT</b> --



Arm Type	Width	Article number
Type <b>10</b>	100 mm	03 -- -- -- <b>10</b>
Type <b>18</b>	180 mm	03 -- -- -- <b>18</b>
Type <b>14</b>	140 mm	03 -- -- -- <b>14</b>
Type <b>04</b>	40 mm	03 -- -- -- <b>04</b>
Coupling arm		



**Type 04**



**Type 10**



**Type 14**



**Type 18**

Special option touch dimmer

Article number



50TD01LD24

# 33 Piano

LED music stand lamp made of brass with black, flocked switchboard. Every pianist or organist needs good lighting to be able to read their music. This lamp solves the problem of attachment to valuable instruments. It is adjustable in height and attached to a velvet-covered board, which then becomes a music stand. The only wiring is a socket on the bass end of the keyboard. Simply unplug the transformer cable, and the board can be readily removed, together with the lamp, and the piano closed. The fluorescent tube can be rotated and the pianist can adjust the lighting him or herself. Application: music stand lighting, menu lighting.

Material: brass, illuminant: LED, LED-CEE: F, Ra: 90, ballast unit: 220-240V, secondary voltage: DC 24V/12W, panel dimensions: 380 x 250 x 12 mm, total weight: 900 g, rotatable fluorescent tube: Ø 14 mm, bracket tube: Ø 6 mm, bracket width: 190 mm

Scope of delivery: whole lamp with LED illuminant, touch dimmer, plug-in power supply (4-metre long cable) and optional black panel.

**IP20**



**CE**

Design: Horst Lettenmayer © betec

Colour	Length	Light output	Article number
Brass	<b>360 mm</b>	2,5 Watt / 240 Lm	33 MO <b>03</b> MT19

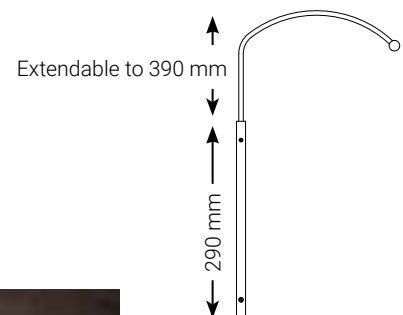



# 27 Galerie 2

Connected load for high-voltage lamps 110 – 230 V as well as for low-voltage operation (LED). Installed as a basic fitting all around rooms in the wall-ceiling joint, paintings can be hung at all heights and distances. At the same time, the electricity for a painting lamp is also conducted.

The suspension pendants made of 6-mm round aluminium are available in different lengths. By simply turning them 90°, they are locked in the busbar slot and supplied with electricity. The load of each pendant is 5 kg. For higher loads, several pendants should be used where necessary. A height-adjustable picture hook is mounted at the lower end of each pendant. With this equipment, you can custom decorate and illuminate each vernissage. Ideal for walls with wood panelling or fabric covering.

Material: aluminium, colour: white RAL9016, light output: 110-230 V, Ampere: 10, rail dimensions: 36 x 12 mm, coupling piece dimensions: 40 x 25 mm, pendant head dimensions: 35 x 10 mm

**IP20**



**CE**

Design: Horst Lettenmayer © betec

Product	Length	Article number
Track	2000 mm	27GS36AS12



As an addition there are the following products:

	Electric picture pendulum with power supply and picture hook	1000 mm	27GP010010
		2000 mm	27GP020010

	Coupling piece with Electricity feed	40 mm	27KS25PW40
---	--------------------------------------	-------	------------



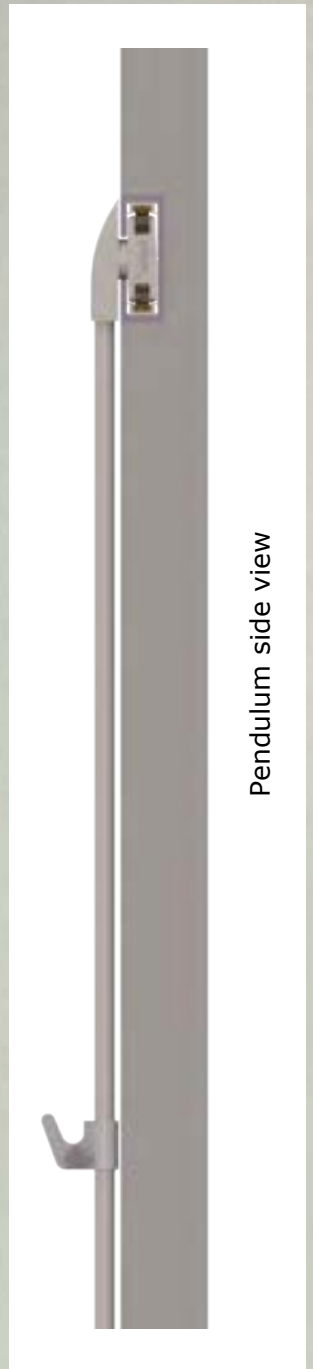

Pendulum side view

# 32 Noctis

As a light pedestal for accentuated room lighting or as an object spotlight for three-dimensional art. Contemporary lighting design lives and breathes on the contrast of light and dark. Optical focal points are thereby emphasised with light.

Material: brass, illuminant: Power LED, LED-CEE: G, Ra: 90+, Kelvin: 3000K, base dimension: Ø 90 mm, total length: 660 mm

Scope of delivery: whole lamp with integrated ballast unit and touch dimmer.

**IP20**



**CE**

Design: Horst Lettenmayer © betec

Length	Colour	Light output	Article number
<b>360 mm</b>	Brass	3,5 Watt / 172 Lm	32MO03PT00

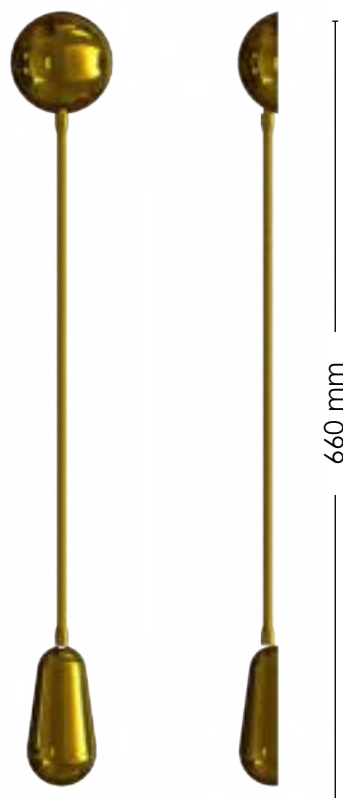



# 05 Acus Office

A piece of minimised technology. Aesthetics in motion and workmanship. Clear relationships as to form and functionality. The lamp is attached to the table-top with an elaborately developed, patented clamping foot. The light stand can be raised or lowered as desired. The fluorescent tube's inclination is fully adjustable from a horizontal to a vertical position. In addition, the fluorescent tube, and therefore the light output can be rotated by 140°.

All electronic components as well as the switch are located as a ballast inside the thickened fluorescent tube. The wiring is 2.5 metres in length. Two rocker arms on the lamp make assembly tools unnecessary. The elegant, handmade lamp is destined to be a classic.

Material: brass, illuminant: Power LED, LED-CEE: F, Ra: 92+, Kelvin: 3100K, rotatable fluorescent tube: Ø 18 mm, lamp length: 1300 mm, height adjustability: up to max. 800 mm, plate thickness: up to max. 35 mm

Scope of delivery: whole lamp with illuminant and plug-in power supply.

**IP20**



**CE**

Design: Horst Lettenmayer © betec

Length	Colour	Light output	Article number
<b>1300</b> mm	Chrome polished	16 Watt / 1048 Lm	05CO <b>13</b> PT18

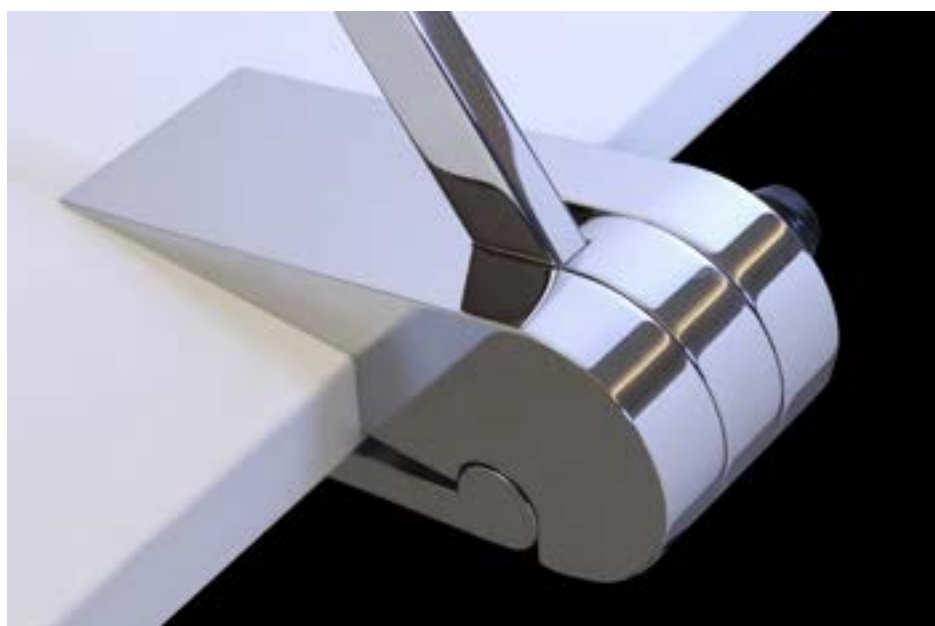



# 11 Centre oú

Art needs to be positioned well in a room to be effective. At the same time, the art requires special lighting. The purpose of this source of light is to place the work of art centrally for the viewer. Art does not follow light, but rather light follows art. Sculptures or pictures shape the room with their structure, colour and relief. Their effect is emphasised with this light effigy – from a warmly dimmed glow to bright white floodlights. Harmony of art and light to perfection. The brightness can be adjusted via a dimmer control.

Material: brass, illuminant: dual LED, lifespan: 50,000 hours, LED-CEE: F, light colour: 3100K, Ra: 94+, primary voltage: 220V - 240V, primary voltage: 220V - 240V, dimmable: via touch dimmer, rotatable fluorescent tube: Ø 18 mm, total height: 950 mm, base dimensions: 100 x 100 x 50 mm

Scope of delivery: whole lamp with illuminant and power supply.

**IP20**



**CE**

Design: Dr. Thomas Schrade & Horst Lettenmayer © betec

Length	Colour	Light output	Article number
<b>950</b> mm	Nickel polished	16 Watt / 1011Lm	11NO09DT15





# 40 Studeo

We developed these „Biblio“ lamps for the LMU Munich-Garching library and delivered them to them. However, innovation is our goal and this is why we improved it to this new „Studeo“ version. The solution for non-reflecting light. Due to the inclined position of manuscripts on the lamp housing, the workspace for students is not halved and there are no reflections. This angle also facilitates reflection-free reading. The lamp can be dimmed on the housing and switched on and off. A USB charging socket and a 220-volt socket for charging laptops and other devices are installed in the base. The lamp is protected against vandalism.

Material: aluminium, illuminant: Duo LED, EEC: F, RA: 92+, Kelvin: 2700K, rotatable lighting profile: 15 x 15 mm – length: 400 mm, socket: 220V, housing 400 x 80 mm, operational protection for group systems used at universities, cable for single operation. In group operation, the series connection is routed under the table, gooseneck with Ø 9 mm x 300 mm. Tilttable at 2 x 45°.

Scope of delivery: lamp delivered with illuminant and diffuser cover as well as lamp fitting with integrated ballast and USB socket, on/off switch, dimmer, socket.

**IP20**



CE



Design: Horst Lettenmayer © betec

Colour

Light output

Article number

Aluminum powder coated

8,5 Watt

40AS40DN30







# 26 Cappello

The LED era makes it possible to design unconventional lighting. With this lamp, the light is no longer centre stage, but the lampshade itself is the light. Power is supplied via a 2.5 m cable power pack and a miniature jack plug directly in the lampshade, and is switched on and off using a cable switch. If you wish to greet your host with the obligatory champagne bottle in your hand for your next invitation, simply put this lampshade over the bottleneck.

Material: Fabric, illuminant: LED, lifespan: 50,000 hours, LED-CEE: F, light colour: 2700K, Ra: 94+, primary voltage: 100V - 240V

Scope of delivery: lampshade with LED illuminant and plug-in power supply with rocker switch.

**IP20**



**CE**

Design: Horst Lettenmayer © betec

Length	Colour	Light output	Article number
<b>250 mm</b>	Red	7,5 Watt / 517 Lm	26RT25MN30
<b>200 mm</b>	Black	7,5 Watt / 517 Lm	26SO20MN30





# 05 Acus

Wherever illumination is desired in a room in vertical or horizontal form, this modern light needle expresses innovative elegance. Application: office, object, shop window, or stand lighting lamp for modern sculptures and large paintings.

Material: brass, illuminant: power LED, lifespan: 50,000 hours, LED-CEE: F, light colour: 3000K, Ra: 90+, primary voltage: 220V - 240V, fluorescent tube: Ø 16 mm, base plate: Ø 294 mm, height: 2150 mm

Scope of delivery: whole lamp with illuminant, touch dimmer and plug-in power supply.

**IP20**



**CE**

Design: Horst Lettenmayer © betec

Length	Colour	Light output	Article number
<b>2150</b> mm	Chrome polished	18 Watt / 1183 Lm	05CO21PT17





# 11 Obelisk 1900

Light can significantly support the emphasis on focal points in a room. With this graceful light column, walls can be brightened, or silhouettes created, in a targeted manner. All the power components are housed in the lamp's conical base. Application: office, object, shop window, and stand lighting lamp for modern sculptures and large paintings.

Material: brass, illuminant: dual LED, lifespan: 50,000 hours, LED-CEE: E, light colour: 3000K, Ra: 90+, primary voltage: 220V - 240V, fluorescent tube: Ø 34 mm, base plate: Ø 294 mm, height: 1900 mm

Scope of delivery: whole lamp with illuminant, touch dimmer and plug-in power supply.

**IP20**



**CE**

Design: Horst Lettenmayer © betec

Length	Colour	Light output	Article number
<b>1900</b> mm	Chrome polished	27Watt / 2688Lm	11CO19DT00
<b>1900</b> mm	Nickel mat	27Watt / 2688Lm	11NM19DT00





# 10 LUXUS

Bright, glare-free table lamp in an „Art Deco“ style as a high-quality, hand-made designer lamp. The lamp head can be rotated up to 360° and distributes the light on tables, walls or ceilings in a pleasant way. The „Luxus“ table lamp is equipped with 7 power LEDs and is technologically very modern with a retro look.

Material: brass, illuminant: power LED, lifespan: 50,000 hours, LED-CEE: F, light colour: 3000K, Ra: 90+, primary voltage: 220V - 240V, colour rendering index: 90, dimmable: via touch dimmer, base dimensions: 200 x 200 x 20 mm

Scope of delivery: whole lamp with illuminant, plug-in power supply and touch point.

**IP20**



**CE**

Design: Horst Lettenmayer © betec

Length	Colour	Watt/Lumen	Article number
<b>650</b> mm	Nickel polished	21Watt/3000Lm	10NO03PT01
<b>650</b> mm	Brass polished	21Watt/3000Lm	10MO03PT01
<b>1270</b> mm	Nickel polished	21Watt/3000Lm	10NO04PT01
<b>1270</b> mm	Brass polished	21Watt/3000Lm	10NO04PT01
<b>1850</b> mm	Nickel polished	28Watt/5850Lm	10NO05PT01
<b>1850</b> mm	Brass polished	28Watt/5850Lm	10MO05PT01







# 25 Filum

Height-adjustable pendant lighting fixture with touch dimmer and switching technology. Fluorescent tube can be rotated 360° for targeted lighting. The switching and stepless dimming functions are executed by touching the pin in the fluorescent tube. The pendant lamp is suitable for all ceiling heights, since the cable lengths can be individually adjusted. The fluorescent tube is made of brass and then plated in shiny chrome. The geometric counterweight is made of black plastic.

Material: brass, illuminant: dual LED, LED lifespan: 50,000 hours, LED-CEE: F, light colour: 3000K, Ra: 90+, dimmable: touch dimmer, primary voltage: 220V - 240V, secondary voltage: DC 24V, ECG ceiling fixture: 75 x 70 mm, rotatable fluorescent tube: Ø 18 mm

Scope of delivery: complete luminaire with ceiling mount including electronic LED ballast unit in the ceiling fixture and touch dimmer on the fluorescent tube. Pendant cords as standard for a ceiling height of 3.10 metres.

**IP20**



Design: Horst Lettenmayer © betec

Length	Colour	Light output	Article number
<b>891</b> mm	Chrome polished	16 Watt/1536Lm	25CO <b>09</b> DT16
<b>1191</b> mm	Chrome polished	22 Watt/2112Lm	25CO <b>12</b> DT22
<b>1491</b> mm	Chrome polished	27 Watt/2688Lm	25CO <b>15</b> DT28





# 12 Hamus

Wall and ceiling light with an aesthetic plastic housing (polycarbonate). Rotatable, with one or two arms and a 4-watt LED spot. Application: whether as a picture light or as a ceiling spot, this variable, complete lamp fulfils all requirements. The plastic cylinder can be fixed into drywall ceilings.

Material: polycarbonate & brass, illuminant: LED, illuminant base: GX 5.3, LED-CEE: F, secondary voltage: DC 12V, primary voltage: 220 - 240V, 12W ballast unit: Ø 55 x 23 mm

Scope of delivery: whole lamp with integrated ballast unit without LED lamp.

**IP20**



**CE**

Design: Horst Lettenmayer © betec

Length	Colour	Article number
<b>Hamus 1</b>	White / Nickel	12WN <b>01</b> LD01
<b>Hamus 1</b>	Black / Nickel	12SN <b>01</b> LD01
<b>Hamus 2</b>	White / Nickel	12WN <b>02</b> LD01
<b>Hamus 2</b>	Black / Nickel	12SN <b>02</b> LD01

As an addition there are the following products:

LED bulbs	2700 K / 4W / 12V / 30°	88LD04OO30
Spot mount	White	62 <b>WO</b> 01LO00
Spot mount	Black	62 <b>SO</b> 01LO00





# 30 Folium

Classic wall lights brighten things up. This lamp's decor takes you on the path of your dreams. As a lamp manufacturer, we not only take care of lighting, but also want to create an atmosphere in which you feel good. Spend your next holidays at home.

Material: powder-coated aluminium, illuminant: power LED, lifespan: 50,000 hours, LED-CEE: F, light colour: 3000K, Ra: 90+, dimensions: 1900 x 180 mm

Scope of delivery: whole lamp with wall bracket and plug-in power supply.

**IP20**



**CE**

Design: Horst Lettenmayer © betec

Length	Colour	Light output	Article number
<b>1900</b> mm	Green/Gold	15 Watt / 986 Lm	30GG19PT00



# 09 Palus

Decorative wall lamp with integrated transformer for two light sources. The technical details are excellently supported by the exciting design. A wall and ceiling spotlight that reflects drawings of light as symmetrical patterns on walls and simultaneously covers floor and ceiling. Application: can also be used as a directional aid in offices and public buildings. In cinemas, museums, foyers, private entrances and clinics as wall brighteners, and to give bistros and cafés a better ambience.

Material: painted aluminium, illuminant: LED 2 x 4W, illuminant base: GX 5.3, LED-CEE: F, secondary voltage: DC 12V, primary voltage: 220 - 240V, 12W ballast unit: integrated.

Scope of delivery: whole lamp with 2 LED lamps and wall bracket.

**IP20**



**CE**

Design: Horst Lettenmayer © betec

Length	Colour	Light output	Article number
<b>400 mm</b>	White	8 Watt	09 <b>WO</b> 02DN02
<b>400 mm</b>	Red	8 Watt	09 <b>RO</b> 02DN02
<b>400 mm</b>	Silver	8 Watt	09 <b>AO</b> 02DN02

The following product is available as illuminant:

Illuminant above	2700 K	1 x 4W / 30°	88LD04OO30
Illuminant below	2700 K	1 x 4W / 60°	88LD04OO60







# 14 Oyster

True to its name, the shell-shaped lamp bowl offers a large propagation of light. The powerful LED light with 3000 Kelvin gives this shapely product a wide range of applications. As wall lighting for halls and rooms. Therefore, this lamp offers good lighting for walls and ceilings.

Material: cast aluminium and stove-enamelled in white or anodised in silver, illuminant: LED 28W, EEC: F, dimensions: 352 x 235 x 168 mm, secondary voltage: DC 12V, primary voltage: 110/230V, ballast 30W: integrated.

Scope of delivery: lamp delivered with built-in LED illuminants.

**IP20**



**CE**

Design: Horst Lettenmayer © betec

Colour

Light output

Article number

Painted white  
anodised silver

28 Watt  
28 Watt

14**WO**01MT01  
14**AO**01MT01





# 10 LUXUS

Powerful, glare-free wall lamp in the style of „Art Deco“ as a high quality handmade design lamp. The light head can be rotated up to 360 ° and pleasantly distributes the LED light on the wall or on the ceiling. The „Luxus“ is equipped with 120 Power PCS LEDs. Modern technology in a retro guise.

Material: brass, illuminant: Power LED, RA: 92+, lifespan: 50,000 hours, efficiency class: A ++, light color: 3000K, voltage primary: 220V - 240V

Scope of delivery: Luminaire complete with illuminant and integrated ballast in the wall base.

**IP20**



**CE**

Design: Horst Lettenmayer © betec

Length	Colour	Light output	Article number
<b>190 mm</b>	Nickel glanz	21Watt/3000Lm	10NO01PT01
<b>190 mm</b>	Messing glanz	21Watt/3000Lm	10MO01PT01

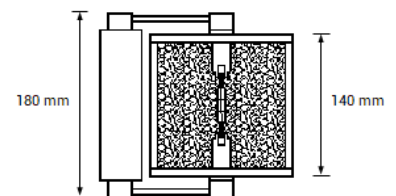
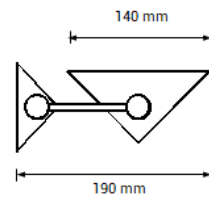
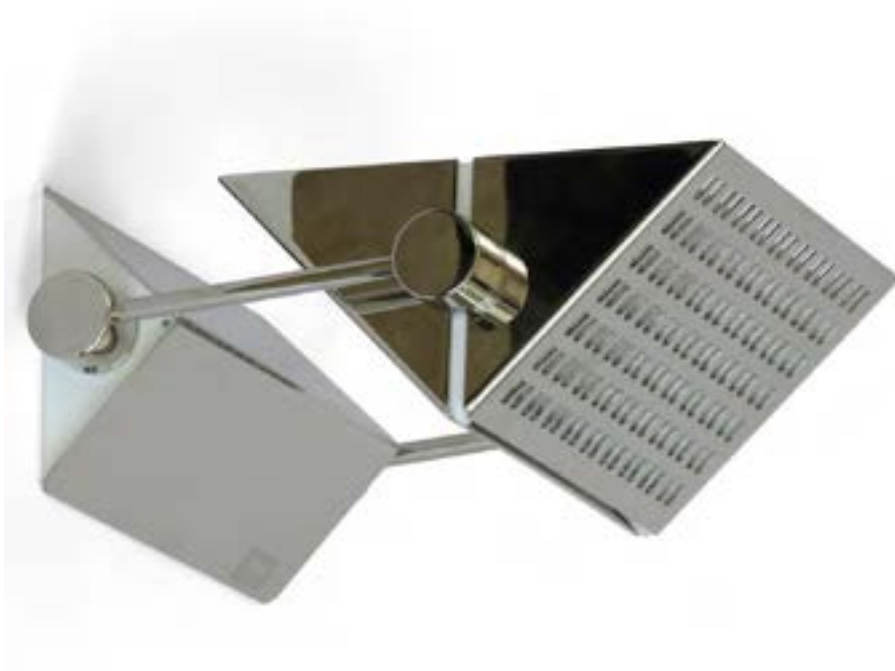



# 28 Cubus

Stylish linear fluorescent LED lamp designed as a modern chandelier in aluminium. Dual strip lights with a 2400 or 3000 Kelvin light colour are located within the U-beams. This way, the core brightness is distributed over a large volume of space without glare. Its unobtrusive design provides harmonisation in both classic arcades as well as modern halls and archways. The light output is 88 watts and can be dimmed steplessly. The acrylic-covered strip lights make this lamp last up to 50,000 hours without maintenance. The length of the suspension pendant can be supplied as per the customer's wishes.

Material: aluminium, illuminant: dual LED, lifespan: 50,000 hours, LED-CEE: F, light colour: 2700K, Ra: 94+, ceiling plate: 40 x 40 mm, suspension pendant: Ø 18 x 1200 mm, chandelier dimensions: 1200 x 400 mm, ballast 2 x 80W: 230x51x40 mm

Scope of delivery: whole lamp with built-in LED illuminant, plexiglass cover.

**IP20**



**CE**

Design: Gottfried Riesner © betec

Length	Colour	Light output	Article number
<b>1200</b> mm	White	105 Watt / 3520 Lm	28WO12DN04
<b>1200</b> mm	Black	105 Watt / 3520 Lm	28SO12DN04
<b>1200</b> mm	Gray	105 Watt / 3520 Lm	28GR12DN04
<b>1200</b> mm	Silver anodised	105 Watt / 3520 Lm	28SE12DN04

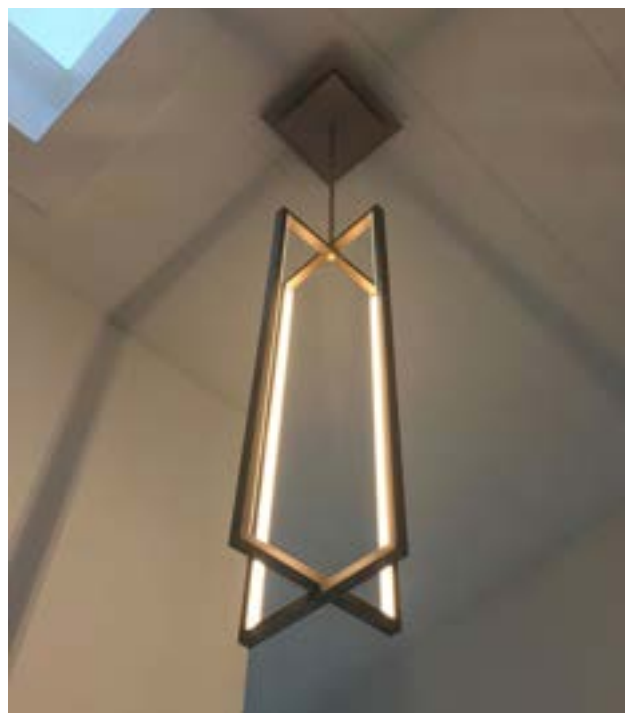



# 15 Etagere

Shelf lamp for retrofitting. An aluminium angle profile equipped with a continuous LED strip and a transparent cover. This lamp can also be delivered according to customers' specified dimensions. Whether in the private or in the commercial sector, these types of light walls manage to make rooms appear larger. At the same time, their decorative effect enriches the ambience of rooms significantly.

Material: aluminium, illuminant: Duo LED, EEC: F, light colour: 3000K, RA: 94+, voltage: 110-230V/24V, profile dimensions: 18 x 18 mm, dimmable

Scope of delivery: whole lamp with cover and plug-in power supply.

**IP20**



**CE**

Design: Horst Lettenmayer © betec

Length	Colour	Light output	Article number
<b>560</b> mm	Silver Anodized	13 Watt/1760Lm	15AS05DN00
<b>1000</b> mm	Silver Anodized	23 Watt/3040Lm	15AS10DN00







# 15 Vestiaire

The classic wardrobe rail has now turned into wardrobe lighting. High-quality brass tube with two decorative rings enclosed by a continuous LED light strip with a 3000 Kelvin light colour. This lighting makes the often tedious choice of what to wear easier. If the wardrobe doors are closed, the light will then automatically switch on when the doors are opened. On request, the lamp can also be delivered according to the dimensions you need.

Material: brass, illuminant: power LED, lifespan: 50,000 hours, LED-CEE: F, light colour: 3000K, Ra: 92+, primary voltage: 220V - 240V, secondary voltage: DC 24V, tube dimensions: Ø 34 mm

Scope of delivery: whole lamp with two decorative rings and mounting blocks as well as ballast unit. (Cabinet switch will be charged extra)

**IP20**



CE

Design: Horst Lettenmayer © betec

Length	Colour	Light output	Article number
<b>500</b> mm	Brass polished	9,5Watt/625Lm	15MO05PT00
<b>500</b> mm	Chrome polished	9,5Watt/625Lm	15CO05PT00
<b>750</b> mm	Brass polished	19Watt/1250Lm	15MO07PT00
<b>750</b> mm	Chrome polished	19Watt/1250Lm	15CO07PT00

As an addition there are the following product:

Door pressure switch

65DS00LD00





# 29 Magnus

High-quality 6 mm crystal mirror with indirect circular LED lighting. A dimmer switch on the back of the mirror can regulate the brightness steplessly. We make this high-quality product in our lamp manufactory. A highly decorative spatial element. Perfect for beauty areas as a make-up mirror, in theatres or hotels. Due to its enormous size, this mirror meets all requirements for customer presence.

Material: brass, illuminant: Power LED, EEC: F, light colour: 3000K, Ra: 92+, mirror shell: Ø 110 cm, mirror: Ø 90 cm

Scope of delivery: complete mirror with illuminant, touch dimmer, ballast unit and wall mount.

**IP20**



**CE**

Design: Formstelle © betec

Product	Colour	Light output	Article number
Magnus	Brass polished	95 Watt / 6165Lm	29MO11PT00
Magnus	Brass mat	95 Watt / 6165Lm	29MM11PT00



Photo: Formstelle Munich, Pony Club



# 06 Make up 3

The illuminated make-up mirror lends every room an exclusive elegance. In addition to the modern design, the warm light of the LED illuminant also provides optimal lighting. These mirror lights frame your reflection with light. Whether you angle the pivotable light to reflect off the mirror or to face you for direct illumination is up to you. These lights are plug-in, so they are easy to access for servicing at any time.

Material: brass, illuminant: single LED, lifespan: 50,000 hours, LED-CEE: F, primary voltage: 220V - 240V, secondary voltage: DC 24V, 2x lamps 880mm & 1x lamp 470mm, 30W ballast unit: 133 x 46 x 24 mm, rotatable fluorescent tube: Ø 14 mm, borehole: Ø 18 mm

Scope of delivery: whole lamp with illuminant and ballast unit without mirror.

**IP20**



CE

Design: Horst Lettenmayer © betec

Product	Colour	Light output	Article number
2x 880mm & 1x 470mm	Nickel polished	16 Watt	06NO03MN <b>03</b>

Colour	Article number
Brass polished	06 <b>MO</b> -- -- --
Chrome	06 <b>CO</b> -- -- --
Nickel polished	06 <b>NO</b> -- -- --
Nickel mat	06 <b>NM</b> -- -- --

LED-Light colour: -- -- -- **M** --

2400K	Warm tone	RA 80+ / 750 Lm	06 -- -- <b>MW</b> --
2700K	Neutral	RA 90+ / 1640 Lm	06 -- -- <b>MN</b> --
3000K	Daylight	RA 90+ / 750 Lm	06 -- -- <b>MT</b> --

Special option touch dimmer Article number



56TD00LD24



# 06 Make up 5

Plug-in attachment light in a 24mm-diameter frosted glass tube. Creates optimal light distribution in the mirror, in the room and on the viewer. A flattering, first-class make-up lamp. With a patented LED illuminant. This mirror was developed as a make-up mirror for TV makeup artists. This geometry of the light is supported by the 3-strip LED tube, developed by us, with a beam angle of 3 x 130 degrees. These lights are plug-in, so they are easy to access for servicing at any time.

Material: brass, illuminant: single LED, lifespan: 50,000 hours, LED-CEE: F, primary voltage: 220V - 240V, secondary voltage: DC 24V, fluorescent tube: Ø 24 mm, glass tube: matted glass

Scope of delivery: whole lamp with LED illuminant and dimmable ballast unit without mirror.

**IP20**



**CE**

Design: Horst Lettenmayer © betec

Colour

Article number

Brass polished

06 **MO** -- -- --

Chrome

06 **CO** -- -- --

Nickel polished

06 **NO** -- -- --

Nickel mat

06 **NM** -- -- --

Length

Colour

Light output

Article number

**581** mm

Nickel polished

15 Watt

06NO**06**TT05

**881** mm

Nickel polished

24 Watt

06NO**09**TT05

LED Trio + Light colour:

-- -- -- **T** --

2400K

Warm tone

RA 80+ / 2250 Lm

06 -- -- **TW** --

2700K

Neutral

RA 90+ / 4920 Lm

06 -- -- **TN** --

3000K

Daylight

RA 90+ / 2250 Lm

06 -- -- **TT** --

Special option touch dimmer

Article number



56TD00LD24





# 06 Make up 6

Inspired by the „Art Deco“ era, this form shows classical modesty and cool aloofness. Here, too, you can choose the colour combination you want for the white frosted glass tube and metallic accessory. Double-light fixture, mounted in the mirror. A flattering, first-class make-up lamp. The rotatable LED tubes achieve optimal lighting due to their distance from the mirror. This mirror was developed as a make-up mirror for TV make-up artists. These lamps are plug-in, so they can be accessed for servicing at any time.

Material: brass, illuminant: triple LED, LED lifespan: 50,000 hours, LED-CEE: F, primary voltage: 220V - 240V, secondary voltage: DC 24V, fluorescent tube: Ø 34 mm, glass tube: matted glass

Scope of delivery: whole lamp with LED illuminant and dimmable ballast unit.

**IP20**



**CE**

Design: Horst Lettenmayer © betec

Colour

Article number

Brass polished

06 **MO** -- -- --

Chrome

06 **CO** -- -- --

Nickel polished

06 **NO** -- -- --

Nickel mat

06 **NM** -- -- --

Length

Colour

Light output

Article number

**581** mm

Nickel polished

15 Watt

06NO**06**TT06

**881** mm

Nickel polished

24 Watt

06NO**09**TT06

LED Trio + Light colour:

-- -- -- **T** --

2400K

Warm tone

RA 80+ / 2250 Lm

06 -- -- **TW** --

2700K

Neutral

RA 90+ / 4920 Lm

06 -- -- **TN** --

3000K

Daylight

RA 90+ / 2250 Lm

06 -- -- **TT** --

3100K

Bright white

RA 90+ / 4920 Lm

06 -- -- **TH** --

Special option touch dimmer

Article number



56TD00LD24



# 06 Make up 7

Optimal mirror lamp that provides simultaneous room lighting in a classic design. Ideally suited for economical room lighting in guest toilets. The lamp can be mounted either on the wall or on the back of the mirror.

Material: brass, illuminant: triple LED, LED lifespan: 50,000 hours, LED-CEE: F, primary voltage: 220V - 240V, secondary voltage: DC 24V, fluorescent tube: Ø 34 mm, glass tube: matted glass

Scope of delivery: whole lamp with LED illuminant, assembly set and dimmable ballast unit.

**IP20**



**CE**

Design: Horst Lettenmayer © betec

Colour

Article number

Brass polished  
 Chrome  
 Nickel polished  
 Nickel mat

06 **MO** -- -- --  
 06 **CO** -- -- --  
 06 **NO** -- -- --  
 06 **NM** -- -- --

Length

Colour

Light output

Article number

**581** mm  
**881** mm

Nickel polished  
 Nickel polished

15 Watt  
 24 Watt

06NO**06**TT07  
 06NO**09**TT07

LED Trio + Light colour:

-- -- -- **T** --

2400K  
 2700K  
 3000K  
 3100K

Warm tone  
 Neutral  
 Daylight  
 Bright white

RA 80+ / 2250 Lm  
 RA 90+ / 4920 Lm  
 RA 90+ / 2250 Lm  
 RA 90+ / 4920 Lm

06 -- -- **TW** --  
 06 -- -- **TN** --  
 06 -- -- **TT** --  
 06 -- -- **TH** --

Special option touch dimmer

Article number



56TD00LD24



# 06 Make up 8

Extremely minimalistic and yet supremely functional. Assembled as one line of light, this lamp brightens entire rooms. Because the light shines both directly and indirectly into the room, there is no need for additional room lighting. The LED version can be rotated so that the brightness level between direct and indirect lighting can be changed. Application: bathrooms, dressing rooms in private areas, as well as in hotels.

Material: brass, illuminant: triple LED, lifespan: 50,000 hours, LED-CEE: F, primary voltage: 220V - 240V, secondary voltage: DC 24V, fluorescent tube: Ø 18 mm, glass tube: matted glass

Scope of delivery: whole lamp with LED illuminant and dimmable ballast unit.

**IP20**



**CE**

Design: Horst Lettenmayer © betec

Colour	Article number
Brass polished	06 <b>MO</b> -- -- --
Chrome	06 <b>CO</b> -- -- --
Nickel polished	06 <b>NO</b> -- -- --
Nickel mat	06 <b>NM</b> -- -- --

Length	Colour	Light output	Article number
<b>586</b> mm	Nickel polished	15 Watt	06NO <b>06</b> TT08
<b>886</b> mm	Nickel polished	24 Watt	06NO <b>09</b> TT08
<b>1186</b> mm	Nickel polished	33 Watt	06NO <b>12</b> TT08

LED Trio + Light colour: -- -- -- **T** --

2400K	Warm tone	RA 80+ / 2250 Lm	06 -- -- <b>TW</b> --
2700K	Neutral	RA 90+ / 4920 Lm	06 -- -- <b>TN</b> --
3000K	Daylight	RA 90+ / 2250 Lm	06 -- -- <b>TT</b> --

Special option touch dimmer Article number



56TD00LD24



# 06 Discus

High-quality crystal mirror with indirect circular illumination with 56 LED modules connected in series. This design has an extravagant feel. The LED ring light will envelop your face in a flattering but honest manner. A prominent shape highlights your prominent features. It is only natural then that this mirror does not tolerate anything in its reflection apart from what it is supposed to show. The light illuminates the person facing it either as a standing version or as a wall mirror. The lamp can be regulated steplessly with a dimmer switch and ballast unit. Application: as a make-up mirror in bathrooms, theatres or hotels.

Material: brass, illuminant: LED, lifespan: 50,000 hours, LED-CEE: F, primary voltage: 220 - 240V, mirror circumference: Ø 520 mm, height of the stand: 340 mm, total height: 860 mm

Scope of delivery: whole mirror with illuminant, touch dimmer and ballast unit.

**IP20**



**CE**

Design: Horst Lettenmayer © betec

Type	Colour	Light output	Article number
Stand version	Chrome polished	28 Watt	06CO10MT02

LED Mono + Light colour:

-- -- -- **M** --

2400K	Warm tone	RA 80+ / 750 Lm	06 -- -- <b>MW</b> --
2700K	Neutral	RA 90+ / 1640 Lm	06 -- -- <b>MN</b> --
3000K	Daylight	RA 90+ / 750 Lm	06 -- -- <b>MT</b> --

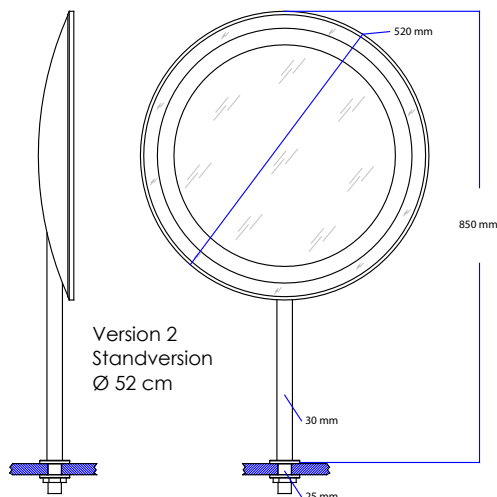





# 22 Disque

The first LED swimming pool spotlight that is also suitable for retrofitting. The name Disque is based on the design of this swimming pool spotlight with an extremely flat back that does not require indented pool walls. This means that the spotlight can be easily installed or retrofitted in a tiled pool or a pool with tried and tested pool liners.

Due to the newly integrated PCS module, there is no temperature control within the spotlight, which allowed for the flat design. The entire spotlight is made of high-quality V4A stainless steel, polished and cast on the inside without bubbles. The front glass is made of VSG safety glass. 16 mm installation height. The LED light is steplessly dimmable (PWM ballast on request).

Material: V4A stainless, polished, anti-algic, diameter: Ø 185 mm, depth: 16 mm, illuminant: LED, operating voltage: 24V, EEC F, light colour: 3000 Kelvin, RA: 92+, total: 2500 mA, light field: 700 x 850 mm, beam angle: 130°, range: 8 m at 50%

Scope of delivery: a spotlight with encapsulated LEDs, fastening set and 110-230V/30W plug-in power supply. With 5 metres of cable.

**IP68**



**CE**

Design: Horst Lettenmayer © betec

Length	Colour	Light output	Article number
<b>185 mm</b>	V4A polished	21Watt/3000Lm	22VA18PT21





# 16 Planus

A complete lighting system with integrated transformer for max. 2 m busbar, which is snapped into the aesthetically shaped cover housing with a clip. The position of the conductor in the housing is variable. Centralised or projecting left-right. The standard Lux 1 spot has a joint that can be tilted by 180°. Version 2 comes with our Lux 3 spot, whose light reaches all areas thanks to a double gimbal joint. Application: lighting system for low ceilings, small rooms such as children's rooms, corridors, cloakrooms, stairwells; can also be used as a decorative wall lamp in cinemas or on columns.

LED-CEE: F, illuminant: LED, socket: GX 5.3, 1-30W ballast unit: 133 x 46 x 24 mm, dimmability: limited

Scope of delivery: transformer, busbar with 2 retaining clamps for the rail, spots (Lux 1 or Lux 3) without illuminant. The transformer colour is the same as the rail colour.

**IP20**



**CE**

Design: Horst Lettenmayer © betec

Length	Colour	Article number
2000 mm	White & Nickel	16WN02LD01
5 x Lux 1	Black & Nickel	16SN02LD01

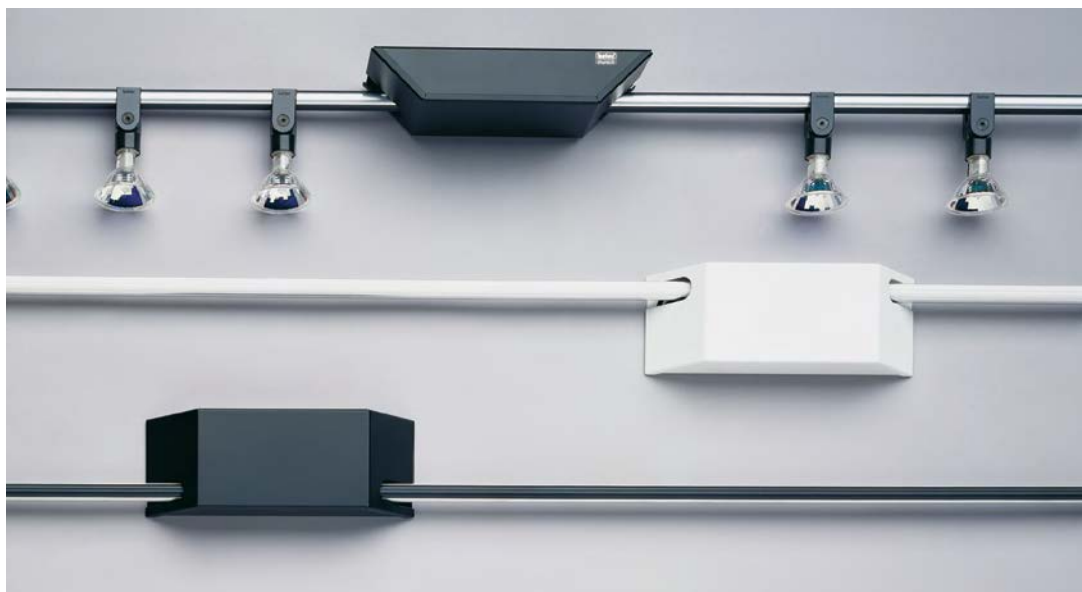



# 19 Galaxis

As far as its conductivity and light output capability is concerned, our galaxy system is the smallest low-voltage busbar system on the market. The circular conductor with a diameter of 15 mm integrates two conductor profiles of nickel-plated or gold-plated colour with a single cross-section of 55 mm<sup>2</sup>. This means you can have a long rail control system without a drop in voltage. Single rails can be mechanically and electrically connected using plug pins or coupling shells. The toroidal transformer with 300 VA integrated in the system acts as a voltage source (dimmability is limited). Two triangular plates are used to supply power to the rail and for optimal adjustment within the room.

Transformer: 300 VA toroid with thermal switch and miniature fuse, light output: max. 250 watts, LED efficiency class: C, illuminant: MR16, socket: GX5.3, 300W encapsulated transformer: 140 x 50 x 37 mm, dimmable: yes (electrically), limited suitability for LED lamps

Scope of delivery: transformer, busbar with 2 retaining clamps for the rail, spots (Lux 1 or Lux 3) without illuminant. The transformer colour is the same as the rail colour.

**IP20**



**CE**

Design: Horst Lettenmayer © betec

Length	Colour	Article number
2000 mm	Weiß & Nickel	19WN02TR01
	Schwarz & Nickel	19SN02TR01

The following clamp-on spots without bulbs with a GX5.3 base are available as an add-on, which can be ordered according to customer requirements:

Lux 1	Schwarz	69SL010005
Lux 1	Weiß	69WL010005
Lux 3	Schwarz	69SL030005
Lux 3	Weiß	69WL030005

Als Zusatz gibt es folgende Spot Halterung mit Sockel GX5,3:

Lux 5	Schwarz	69SL050005
Lux 5	Weiß	69WL050005



# 69 Galaxis & Planus

Product	Version	Colour	Article number
---------	---------	--------	----------------



The standard spot Lux 1 has a joint that can be tilted by 180°. The Lux 3 has a cardanic double joint which reaches every point in the room with light.



Lux 1 Clamp  
spotlight holder -  
without Illuminant

GX5,3 Socket  
max. 50 Watt

Black  
White

69SL010005  
69WL010005



Lux 3 Clamp  
spotlight holder -  
without Illuminant

GX5,3 Socket  
max. 50 Watt

Black  
White

69SL030005  
69WL030005



Pinza 1 Galaxis Rail  
bracket

Black  
White

69SO01PO00  
69WO01PO00



Pinza 2 Galaxis  
Rail bracket incl.  
electricity feed

Black  
White

69SO02PO00  
69WO02PO00



Pinza 3 Planus  
Rail bracket

Black  
White

69SO03PO00  
69WO03PO00





# 69 Galaxis

The advantage of the galaxy system is that users, architects, planners and project planners can custom-design their lighting concept. Our pin connectors are the latest form of our connection technology, which connects the busbars to one another both mechanically and electrically, but without any effect on the decor. This requires a pin hole in the aluminium conductor.

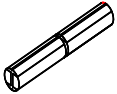
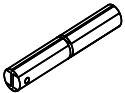
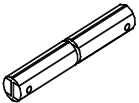
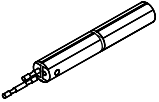
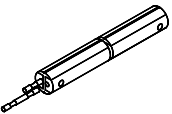
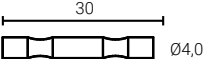
	Length	Colour	Article number
	1000 mm	White & Nickel	69WN00GL01
	2000 mm	White & Nickel	69WN00GL02
For coupling with decorative connectors:			
	Thread on one side		
	1000 mm	White & Nickel	69WN01GL01
	2000 mm	White & Nickel	69WN01GL02
	Thread on both sides		
	1000 mm	White & Nickel	69WN02GL01
	2000 mm	White & Nickel	69WN02GL02
For coupling with feed:			
	Pin hole on one side		
	1000 mm	White & Nickel	69WN01GS01
	2000 mm	White & Nickel	69WN01GS02
	Pin hole on both sides		
	1000 mm	White & Nickel	69WN02GS01
	2000 mm	White & Nickel	69WN02GS02
	Pin connector (Pair)	Brass	69MO10SV18

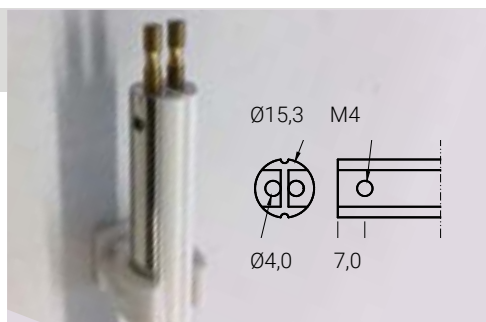

Colour	Article number
Black & Nickel	69SN00GL01
White & Gold	69WG00GL01
Black & Gold	69SG00GL01

# 51 Conversion LED Clarus

The EU Lamp Regulation affects both the 100W-80W incandescent lamp and small lamps. In this context, we would like to point out that we can no longer acquire the following festoons:

**12V, 5W / 15V, 5W / 18V, 5W / 24V, 5W / 48V, 5W**

For reasons of increased light efficiency and a significantly increased lifespan of 50,000 hours, we will retrofit your picture lights that have festoon lamps using versions of the latest LED technology. Increased luminous efficacy with only 10% of the previous electricity consumption, without the lamp or the object heating up.

Illuminant: single LED, lifespan: 50,000 hours, LED-CEE: F, primary voltage: 220V-240V, secondary voltage: DC 24V, 20W ballast unit: 94 x 36 x 18 mm

For safety reasons, retrofittings may only be carried out by electrical industry specialists. Therefore, you should send your lamp to us for retrofitting.

**IP20**



**CE**

Design: Horst Lettenmayer © betec

Length	Light output	Article number
<b>265</b> mm	5 x 48V	51UB <b>26</b> MN24
<b>475</b> mm	10 x 24V	51UB <b>47</b> MN24
<b>595</b> mm	13 x 18V	51UB <b>59</b> MN24
<b>725</b> mm	16 x 15V	51UB <b>72</b> MN24
<b>900</b> mm	20 x 12V	51UB <b>90</b> MN24

LED Duo + Light colour:			-- -- -- <b>M</b> --
2400K	Warm tone	RA 80+ / 750 Lm	51 -- -- <b>MW</b> --
2700K	Neutral	RA 90+ / 1640 Lm	51 -- -- <b>MN</b> --
3000K	Daylight	RA 90+ / 750 Lm	51 -- -- <b>MT</b> --

Special option touch dimmer

Article number



50TD01LD24

# Electronic components

These are always dimmable via phase start and phase cut. Voltage primary: 220-240V, voltage secondary: DC 24V. Also available in 110V on request.

Power	Dimensions	Article number
-------	------------	----------------

**12 Watt**

94x36x18 mm

90VD24LD**12**



**20 Watt**

107x41x22mm

90VD24LD**20**



133x46x24 mm

**30 Watt**

90VD24LD**30**



132x44x28 mm

**40 Watt**

90VD24LD**40**



230x51x40 mm

**80 Watt**

90VD24LD**80**



Our external touch dimmer module is attached behind the picture frame and enables lights to be dimmed directly by touching the metal edge.



Power	Dimensions	Article number
-------	------------	----------------

**70 Watt**

50x18 mm

50TD01LD24

# Special lamps

Project Borgeaud bibliotheques, Médiathèque l'Apostrophe Chartres

March 2007



This light meets high photometric and aesthetic demands for the areas of architecture, interior design and the treatment of furniture. The ideal bookshelf lighting.

Project Théâtre du Capitole Toulouse

February 2002



If large paintings with powerful images are illuminated, a great picture light is required for the optical balance between the image and the light. Our "Maximus" can be adapted to optimally illuminate images with widths of several meters.

# Special lamps

“Ruhe Christi” Church Rottweil

Februar 2018



A betec was installed in the church in 1715 to illuminate the music of the new „Klais Organ“ Organ-light installed. This lamp harmonises ideally with the Swabian Baroque.

“Hotel de Paris” in Monaco

Dezember 2019

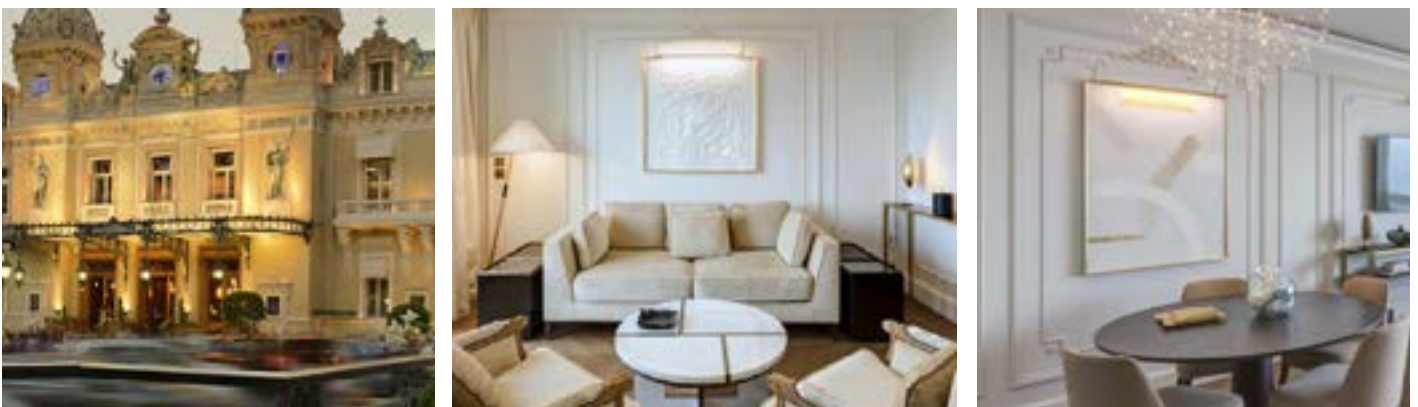

All of the painting lighting in the suites and rooms of this renowned hotel support the aura and well-being of the guests.

# Special lamps

Project Phoenix Restaurant at the Dreischeibenhaus Düsseldorf

February 2016



Special lights made of stainless steel V2A with Halogène bulbs. Design and production of 30 hanging lights and table lamps with fabric-covered cables, designed by the company Kromayer. The perforated metal cylinders have been manufactured and enameled by a German contractor.

Project suburban railway station in Untermenzing

December 2005



Long distance light for indoor and outdoor area lighting with fluorescent tubes. The light housing is made of anodised aluminium. The position of reflectors makes it possible to reflect 100% of the light output of the tube onto a flat surface. At the same time, permanently mounted tubes serve as a handrail strip.

# Special lamps

Library Technical University Garching

December 2017



Customization of the desk lamps with movable arm and console, including USB plug, on/off switch and Socle. 7 Watt, 4000 Kelvin LED light. Surface paint colour DB702.

Archbishop's Ordinariate / Palais Holnstein

September 2017



Wall lamp in the courtyards of the Archbishop's ordinariate. Design: Walter Bamberger /  
Technical implementation: betec Licht AG

# Special lamps

Chandelier LED

April 2017



This chandelier was produced for a construction project in Munich, according to the design of Mr. Gottfried Riesner. We are pleased to continue to include this pendant light in our standard range.

"Salle des illustres" in Toulouse, Picture lighting and ceiling spotlights

Februar 2016



When large and powerful paintings should be illuminated, a larger picture light is used for the optical balance between the image and the light. Our „Maximus“ can be customized to optimally illuminate images with widths of several meters.



# General standard terms and conditions

1. General: with the order confirmation the buyer accepts our delivery conditions to be legally binding unless deviations hereto we agreed to before in writing. They are applicable without any exception in those cases in which the buyer regards his conditions as the only decisive ones. Our silence in regard to the conditions of the purchaser can under no circumstances be regarded as acceptance of same. Any non-compliance with our conditions by the purchaser authorizes us to take the necessary legal steps. Every agreement with us or our representatives needs our written confirmation. The use of the Uniform Laws of 17. July 1973 on the International Purchase of movable items and the closing of International Purchase Orders is excluded.
2. Offers are subject to alteration without notice and are not binding in regard to delivery. We can neither be held responsible for malshipments due to misunderstanding in telexes, telephone, cable, fax or oral information nor from otherwise incomplete or unclear statements, documentation, drawings, samples etc.
3. Prices are ex works, excluding packaging, plus VAT. The agreed prices are based on the cost factor existing at the time of ordering. We retain the right to price corrections in case the cost factors change due to wage- and material price increases, additional working steps in special makes, etc.
4. The duty to deliver will not be cancelled through delayed partial shipments or constant objections, especially in case of custom-made items, Contract completed orders are subject to recall within the agreed period, at the latest after six months. Thereafter we are entitled to either deliver the remainder of the order or cancel the rest. a) A return of goods will only be credited in case of previous consent. The undamaged products in original packaging will be credited with 80% of the invoice price. Necessary extra work and packaging costs plus transportation charges will be subtracted without any prior notice. Custom-made products will not be reaccepted. b) The minimum order value for any shipment is € 50,- (without VAT). For deliveries below this amount a proportionate processing charge of € 10,- (excl. VAT) plus the packaging and shipment costs will be charged. c) Whenever planning or production of special equipment became necessary for the make of the cancelled goods, then those costs will also have to be reimbursed completely; furthermore expenses for any pre-material plus their respective stock and administration charges as far as not intended for any other purpose. Any failures resulting from force majeure or disturbances internally or at our suppliers' plus non-compliance with our payment conditions does not release us from our duty of delivery and justify no claims for compensation. Basically, we can only be bound to delivery if the credit-worthiness of the purchaser is beyond all doubt. A basic ruling of this company is that first orders are subject to C.O.D. deliveries. Our new customers therefore allow us with their first order to send an advance invoice at the latest when goods are ready for shipment which they may regulate with discount. After receipt of payment we will then immediately undertake the shipment. For slow customers the C.O.D.-delivery remains in effect.
5. The given delivery time is dependent upon the prerequisite of a smooth business course and an even production run together with the timely receipt of necessary raw materials. Our information is calculated from the date of confirmation, resp. clarification of all details and refer to the shipment date ex works. An extension of delivery time may be given, e.g. if the purchaser does not keep our business conditions.
6. Tolerances in regard to measurement and material are to be granted as is common also for those according to drawings. Claims exceeding these are subject to a respective surcharge.
7. Special makes, differing from the standard version can only be considered if included in the order or furnished with an order no. If a special product - in spite of most careful planning and calculation - can not be made as laid down in the offer, the purchaser is not entitled to ask for damages. Any costs for the make of tools and samples are to be reimbursed in any case.
8. Packaging is invoiced at prime cost and due to lack of regulations is done in our judgment. The prompt acceptance of the goods through the Post Office, Railway etc. confirm the faultless packing of our goods.

9. Dispatch of goods takes place on account of the purchaser: The risks transferred to the purchaser the moment the goods leave the factory, disregarding whether free of charge, fob or CIF shipments were agreed. If no special transportation mode and no special way are specified, we select the transportation means ourselves. Foreign carriage cannot be compensated. We cannot be held liable for any delays or additional costs for the transportation. We are at all times entitled to shipment by C.O.D., ask for advance payment resp. insure the goods for a small fee.

10. Complaints in regard to number resp. quality of goods can only be considered, if they were handed in in writing within 7 days after receipt of goods. Evidently faulty goods that are still in the shipment state, will be replaced or reworked only irrespective the right to reduce the remuneration or cancel the order when failing the afterwork or replacement delivery, if goods are being returned to us within the permissible complaint period and amounts to more than 5% of the whole shipment. A return of shipped goods may only take place with our consent. All replaced goods will come into our ownership. Further claims, espec. damages, reimbursement of wages and materials are excluded. Our liability for all faults will expire if the purchaser of our products mixes them with items of different origin, reworks himself faulty products or does not meet his contractual obligations. Lamps are technical working means according to the product safety law and may only be used for their intended purposes. Any use of lamps and supplementary parts contrary to their purpose as well as unauthorized changes on our lamps without our prior written consent releases us from all liabilities in case of damage. For losses and damages during transportation the recipient must have those immediately certified with the train- or post office authorities and file claims for compensation there.

11. Reservation of Title. We retain the right of ownership of the delivered goods, even if subsequently treated, until the fulfillment of all claims from this contract. Even if our goods will be connected with other items, the purchaser may only sell the goods under reserved title. Claims from a resale of the reserved goods are to be ceded irrevocably to us in the amount of our claims including interest and costs. In case of possible inability of payment, composition settlement or even pledging resp. bankruptcy of the purchaser, same is bound to return the reserved goods unasked and free of charge. Pawning, protective conveyance or a sale of the reserved goods is excluded. We retain the right to reclaim the reserved goods until their full payment. The enforcement of § 28 VO is excluded.

12. Our invoices are payable within 14 days from invoice date with 2% discount on the net product value or within 30 days net to one of the accounts mentioned on the next page or by cheque to our address. With C.O.D. shipments and immediate advance payment we grant 2% discount on the net product value. We will not accept bills of exchange. Only after their discharge will cheques be regarded as payment. Bank discounts or other expenses are to be charged to the customer. Deductions for transportation or packing costs are inadmissible. Payments because of complaints may under no circumstance be delayed. In case a purchaser does not meet his liabilities, we are entitled to stop further shipments until complete payment. Whenever the deadline for outstanding payments is exceeded, the purchaser - without being specially informed by us - will be levied with an interest that is common for unpaid credits with banks. Extension of time, counterclaims or retention of partial payments, no matter what the reason may be, are excluded without our prior written consent. All expenses arising from a reminder, delayed payment, confiscation or non-acceptance of ordered goods must be borne by the purchaser. Any telephone/cable charges, etc. by the purchaser are also excluded.

13. The guarantee for our products amounts to 24 months. Longer-lasting guarantees must be agreed separately. The guarantee does not refer to bulbs and transformers.

14. Place of performance for shipments and payments is Munich exclusively. The law of Germany applies to our delivery conditions and all legal connections between the purchaser and us.

15. Special regulations or any possible legal ineffectiveness of individual points of these delivery conditions do not infringe the validity of the others.

# Imprint

Chairman: Horst Lettenmayer  
Board of Directors: Julia-Alina Lettenmayer

## Bank details:



Volksbank Raiffeisenbank eG  
IBAN: DE87700915000000414689  
BIC: GENODEF1DCA



Postbank München  
IBAN: DE70700100800081366800  
BIC: PBNKDEFF



Commerzbank München  
IBAN: DE28700400410669930000  
BIC: COBADEFFXXX



Sparkasse Fürstfeldbruck  
IBAN: DE17700530700031764806  
BIC: BYLADEM1FFB

 Recipient: info@betec.de

All lights deviating from this range are special lights and are offered with corresponding surcharges. Initial orders are only carried out against prepayment. Technical changes reserved. All images and all texts are copyrighted by © betec.

Commercial register number: HRB133087, VAT ID: DE129301236

Product photographer: Foto Sessner (Andreas Köhler)  
Texts: Horst Lettenmayer, layout: Julia-Alina Lettenmayer

**betec**<sup>®</sup> Lighting AG  
Felix-Wankel-Str. 10  
85221 Dachau  
Germany

Email: [info@betec.de](mailto:info@betec.de)  
Phone: +49(0)8131 292656  
Fax: +49(0)8131 292651  
Web: [www.betec.de](http://www.betec.de)

Follow us @betecLicht

