



## Features:

- Constant voltage/ PWM Output
- Leading & Trailing edge dimmable
- AC input: 200-240VAC
- Built-in active PFC function
- Efficiency up to 87%
- Protections: Short circuit/ Over loading/ Over current/ Over temperature
- Full protection aluminium housing
- Cooling by free air convection
- Suitable for LED lighting and moving signs



## Models

### ELED-150P-12T

### ELED-150P-24T

## Output Specifications

	ELED-150P-12T	ELED-150P-24T
Output Voltage	12V	24V
Voltage Tolerance		±0.5V
Output Current	12.5A	6.25A
Rated Power		150W

## Input Specifications

Input Voltage	200-240VAC	
Frequency Range	47-63Hz	
Inrush Current	55A (Twidth=220µs 230VAC)	
Full Load Efficiency (Typ.)	87%	86%
AC Current (Max.)	1.2A	
Leakage Current	<0.50mA	
Power Factor	PF>0.97/200VAC PF>0.97/230VAC PF>0.97/240VAC (Full Loading)	

## Protection

Short Circuit	Shut down o/p voltage, re-power on to recover after fault condition is removed
Over Loading	≤120%, shut down o/p voltage, re-power on to recover
Over Temperature	100°C± 10°C shut down o/p voltage, re-power on to recover

## Environment

Working Temperature	-40~+60°C (Refer to derating curve)
Working Humidity	20-95% RH, non-condensing
Storage Temperature, Humidity	-40~+80°C, 10-95% RH
Temperature Coefficient	±0.03%/°C (0-40°C)

## Environment

Vibration 10-500Hz, 5G 12min./ 1 cycle, period for 72min.each along X, Y, Z axes

## Safety & EMC

Safety standards	EN61347-1, EN61347-2-13
Withstand Voltage	I/P-O/P:3.75KVAC I/P-FG:1.88KVAC O/P-FG:0.5KVAC
Isolation Resistance	I/P-O/P I/P-FG O/P-FG: 100MΩ/500VDC/25°C/70%RH
EMC Emission	Compliance to EN55015, EN61000-3-2, 3 (>60%load)
EMC Immunity	EN61000-4-2,3,4,5,6,11, EN61547

## Other Specifications

Weight	1.45 kg
Size	265 x 78 x 47 mm
Packing	265 x 83 x 65 mm (inner box), 340 x 280 x 185 mm (10PCS/CTN)

## Mechanical Specifications

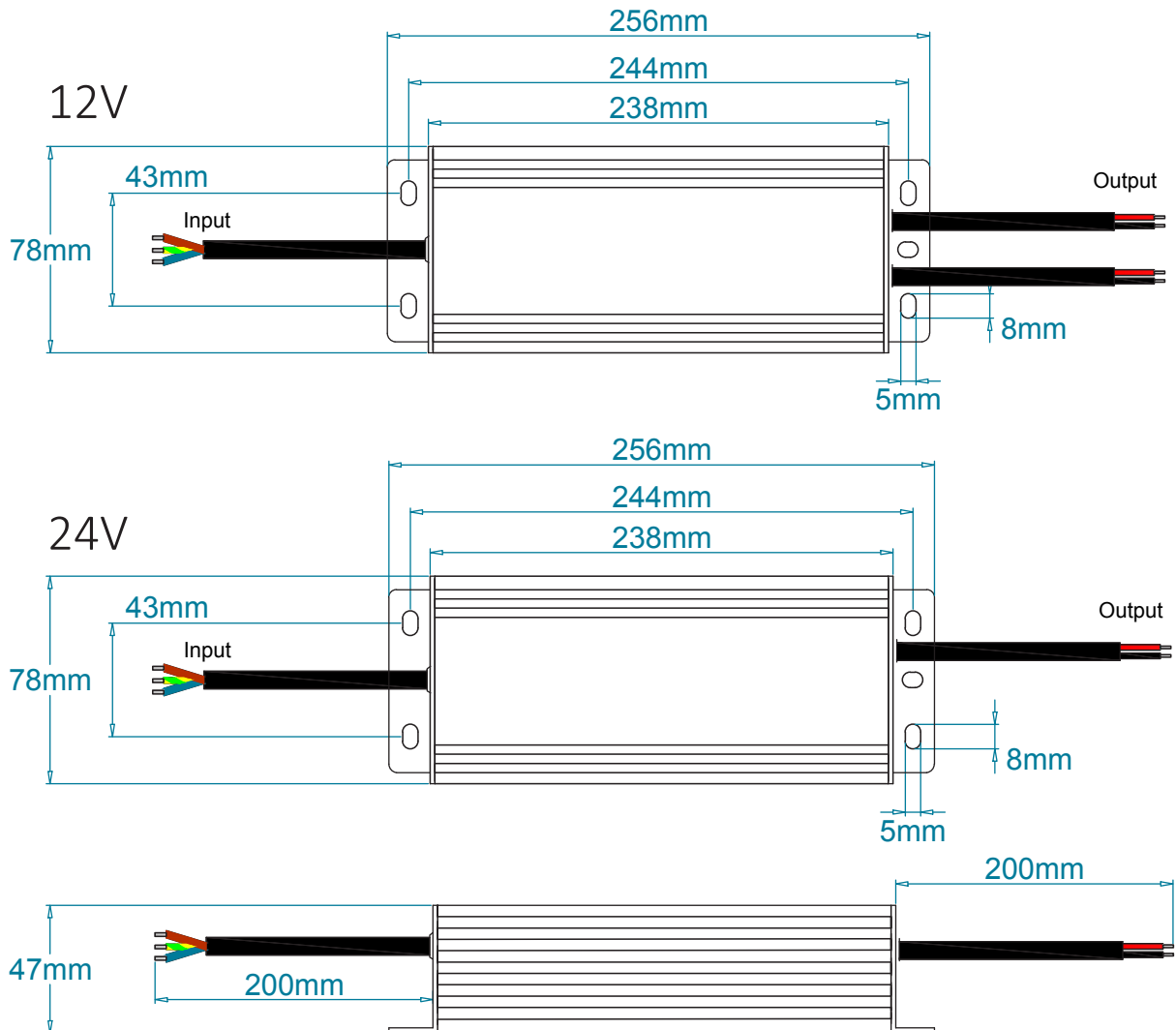

## Derating Curve

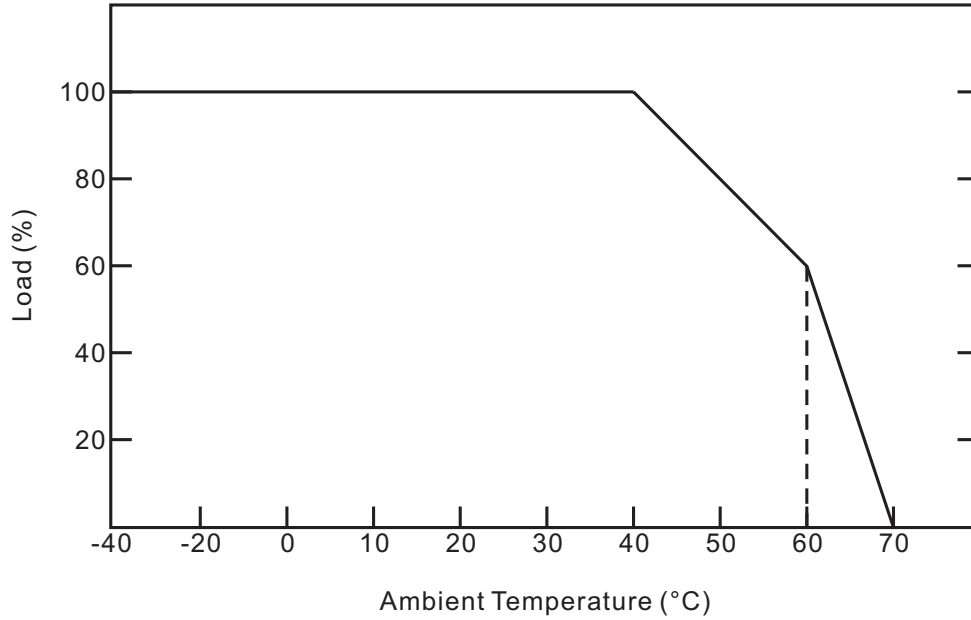

## Connecting Diagram

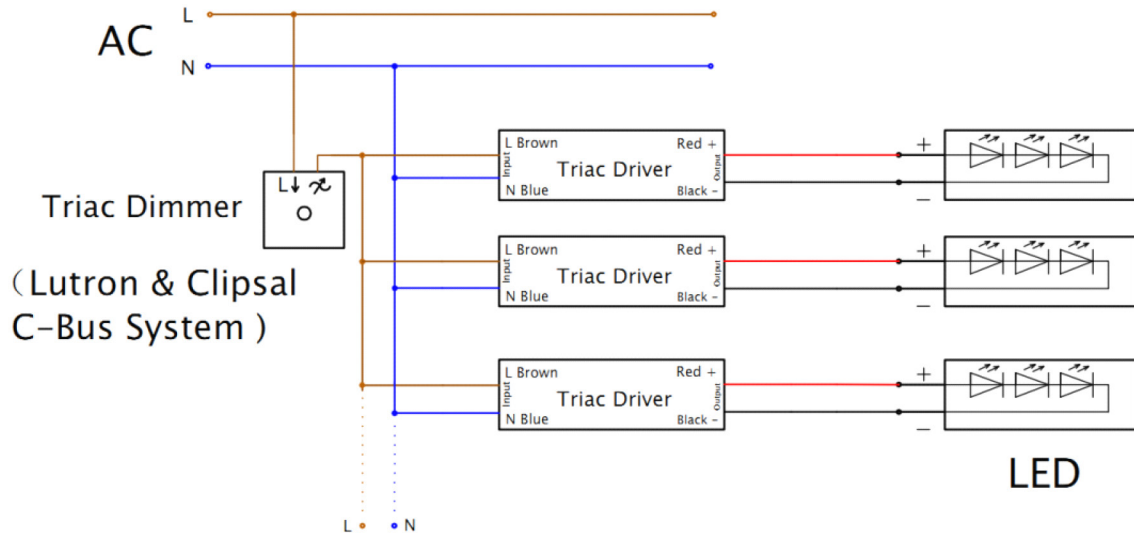

## Connecting Diagram

