

CONSTELLATION

DESIGNED BY ÉMILIE CATHELINÉAU



Asymétrie et démultiplication, *Constellation* offre une infinité de possibilités à composer selon l'espace et vos inspirations. En mural ou au plafond, vos envies se dessinent en points lumineux.



Asymmetry and multiplying, *Constellation* offers an infinity of arrangement possibilities depending on the space and your inspirations. As a wall unit or a ceiling fixture, you can position the light any way you desire to.



Finitions
Finishes ①

 Laiton satiné	 Graphite satiné	 Nickel satiné
SB Satin brass	SG Satin graphite	SN Satin nickel

Finitions
Finishes ②

 Laiton satiné	 Graphite satiné	 Nickel satiné	 Cuivre satiné
SB Satin brass	SG Satin graphite	SN Satin nickel	SC Satin copper

Matériaux
Material

Laiton massif	Verre triplex opale soufflé bouche
Solid Brass	Opal triplex mouth-blown glass

Source
Lamping

LED intégrée	6 x 120 lm	3000° K	Alimentation intégrée fournie	Variation. Veuillez nous contacter
Integrated LED	6 x 120 lm	3000° K	Integrated power supply included	Dimming. Please, contact us
			ou - or	
			Alimentation séparée fournie	
			Remote power supply included	



Designer

Émilie Cathelineau

Alimentation intégrée
Integrated power supply

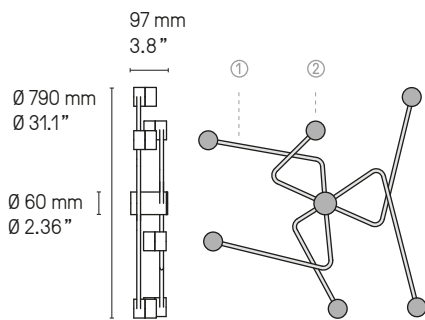

Alimentation séparée
Remote power supply

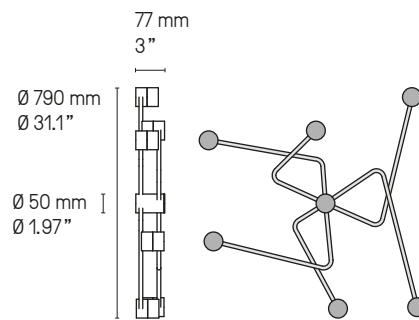

Constellation SG/SB

UL Version
fitted plate to cover outlet power box

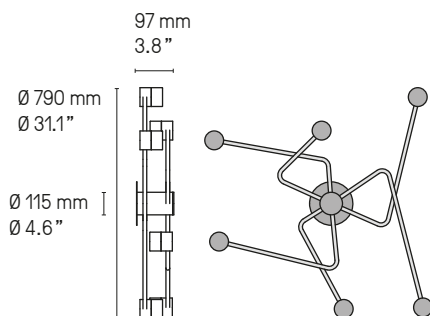

Exemples de compositions, avec 3, 5 et 8 modules
Examples of arrangements, with 3, 5 or 8 units

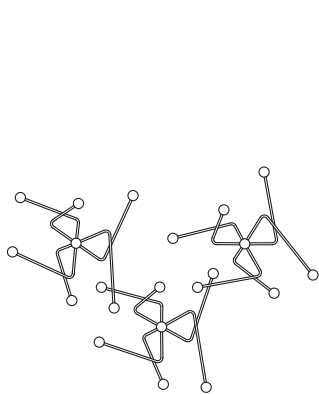

x 3

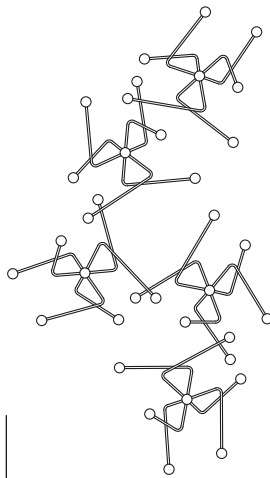

x 5

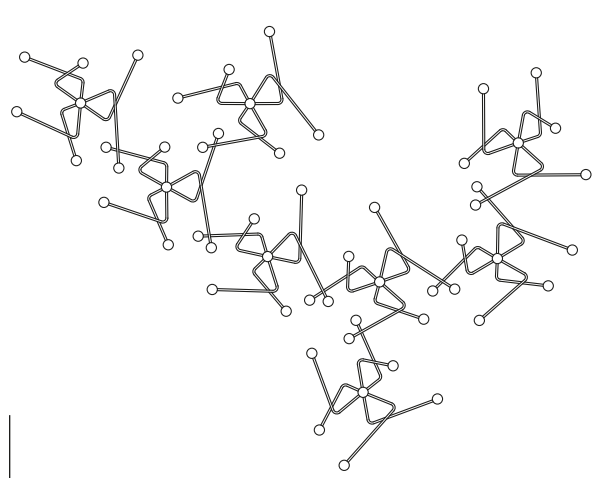

x 8

Version interconnectée
Interconnected version

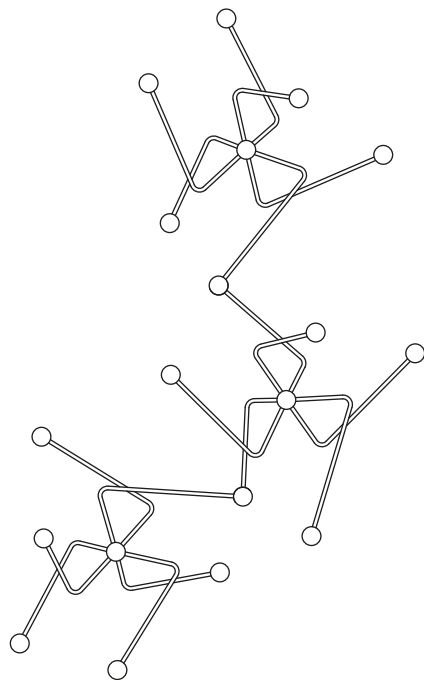

Ce système d'interconnection ne nécessite qu'une seule sortie électrique. Veuillez noter que cette version interconnectée n'est pas certifiée UL et que les points de connections ne sont pas lumineux. Merci de nous contacter pour connaître les compositions possibles.

The new interconnection system requires only one electrical outlet. Please be aware that this interconnected system is not yet UL certified and that the connection points have no light. Contact us for more information on possible arrangements.

NUANCIER - FINISH OPTIONS



LAITON - BRASS

- | | |
|-------------------------------------|---|
| ① Laiton satiné
SB Satin brass | ② Graphite satiné
SG Satin graphite |
| ③ Nickel satiné
SN Satin nickel | ④ Cuivre satiné
SC Satin copper |
| ⑤ Laiton poli
PB Polished brass | ⑥ Graphite poli
PG Polished graphite |
| ⑦ Nickel poli
PN Polished nickel | ⑧ Cuivre poli
PC Polished copper |

ABAT-JOURS - LAMPSHADES

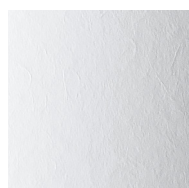

Drop Paper® 100

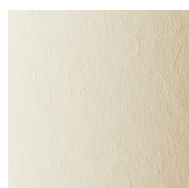

Drop Paper® 101

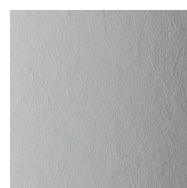

Drop Paper® 103



Chinette blanche
White chinette

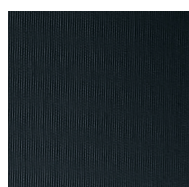

Chinette noire
Black chinette



Duke
Duke

CÂBLES - CABLES

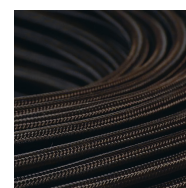

Tissu noir
Black textile



Tissu or
Gold textile

VERRERIE - GLASS



Opale
Opal

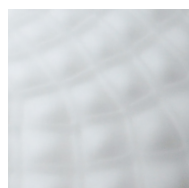

Opale et écaïlle
Opal and patterned



Claire et écaïlle
Clear and patterned



© Yannick Labrousse

CVL LUMINAIRES

79 ROUTE DE LA CHEVALLERIE – 49770 LONGUENÉE-EN-ANJOU – FRANCE

TEL. +33 (0) 2 41 32 67 54

EMAIL : CONTACT@CVL-LUMINAIRES.FR

WWW.CVL-LUMINAIRES.FR

Brand identity & art direction: [POOL](#) Layout & production supervision: [deuxpointdeux](#)
Texts: [Valérie Marion](#) Translation: [CVL](#) Photos: [Garnier Studios](#) except when mentioned otherwise 3D: [CVL](#) except when mentioned otherwise

Make sure to download our latest catalogue [here](#)