

Hanging & Bulb Changing Instructions

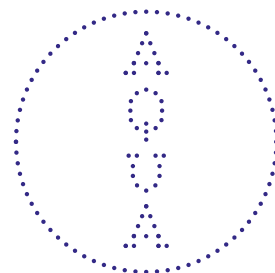

Stand By 76cm 30"
Designed by Aqua Creations



Aqua Creations
Lighting & Furniture Atelier

Aqua Creations Lighting & Furniture Atelier

Stand By 76

Silk Care Instructions

For optimal maintenance vacuum the silk frequently (make sure the vacuum cleaner is at low suction and use a clean attachment) and avoid direct sunlight or smoke. To remove stains use upholstery foam cleaner (as these vary from country to country, testing the product on a hidden spot first is recommended). In case of heavier dirt use a moist sponge and make sure to move it along the crushed line of the silk.

Please do not clean coated lamps with water.

Note that any good quality silk fibers weaken when exposed to sun and natural dyes may fade. Hence, avoid direct sunlight on the silk lights.

220-240 V Model

CFL with ECG 1 x 55W bulb

Optional:

CFL with ECG dimmable [Type C, E] 3 x 15W bulb

CE Certified

120 V Model

CFL with ECG dimmable [Type A] 3 x 15W bulb

UL Listed

Package

Volume: 81 x 25 x 82cm, 32 x 10 x 32"

Weight: 8.4kg / 18.5lb

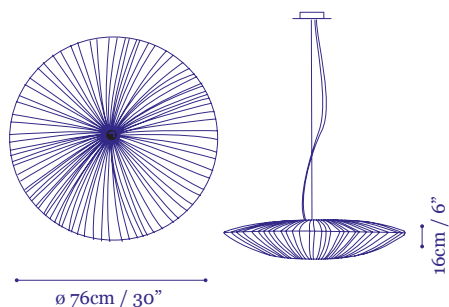

Aqua Creations Lighting & Furniture Atelier

Hanging Instructions Stand By Pendant

Important: the lamp assembly and electrical work should be carried out by a qualified electrician. The Lamp shade's cover should be taken off only after the installation.

Note: Prior to installation, adjust the height of the suspension by cutting the desired length of the electric cable.

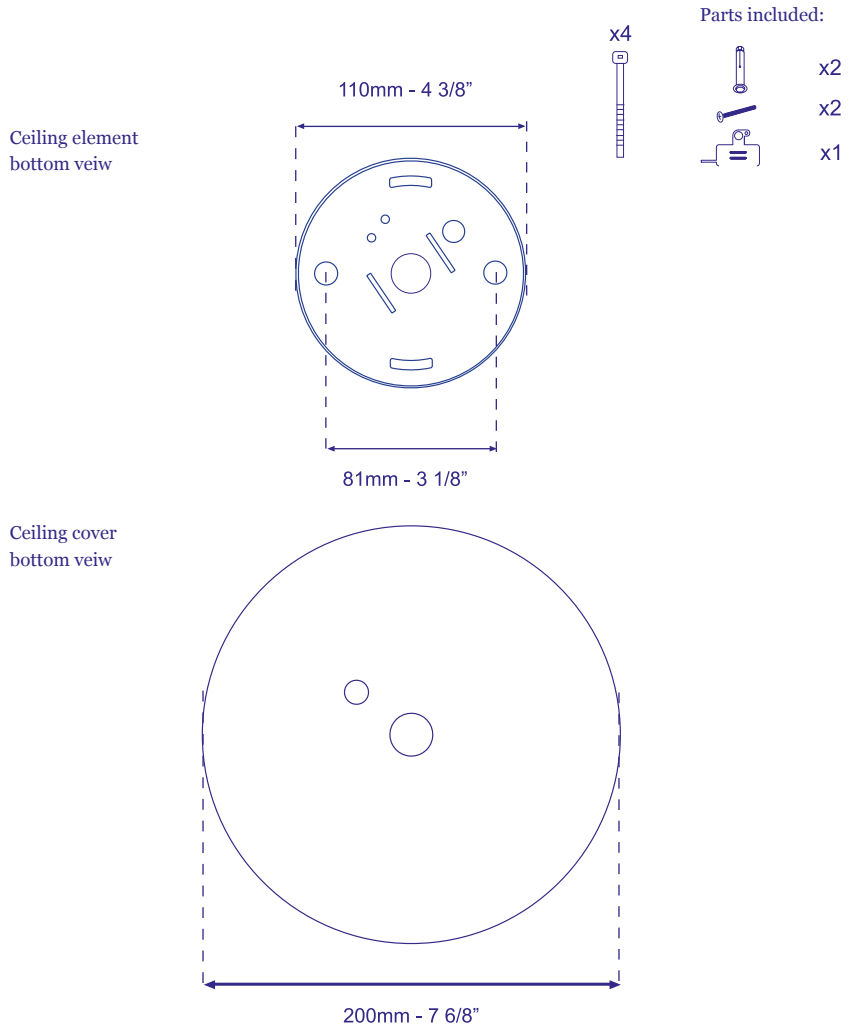

Aqua Creations Lighting & Furniture Atelier

Hanging Instructions Stand By Pendant

Prepare the lamp: Disassemble the hanging element and install the parts as shown in drawing A. Release the three screws marked as “a” hold on to them for later.

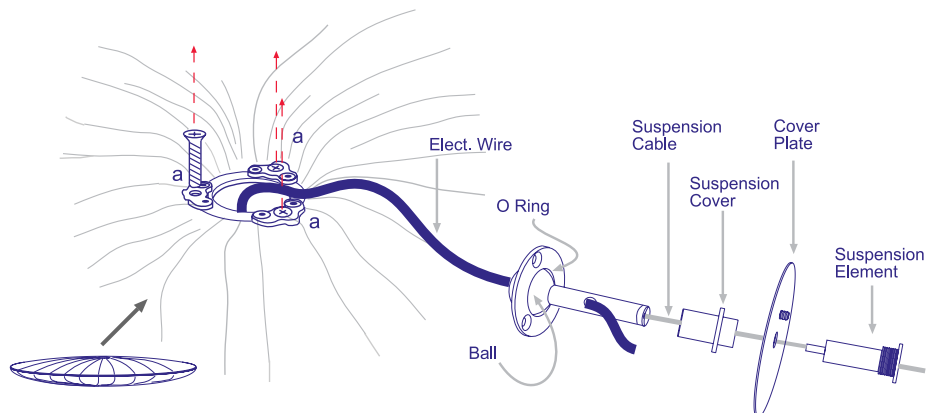

Install the O-ring by tightening the screws shown. Then loosen the 2/1 a turn counterclockwise to allow an almost non-friction movement of the ball.

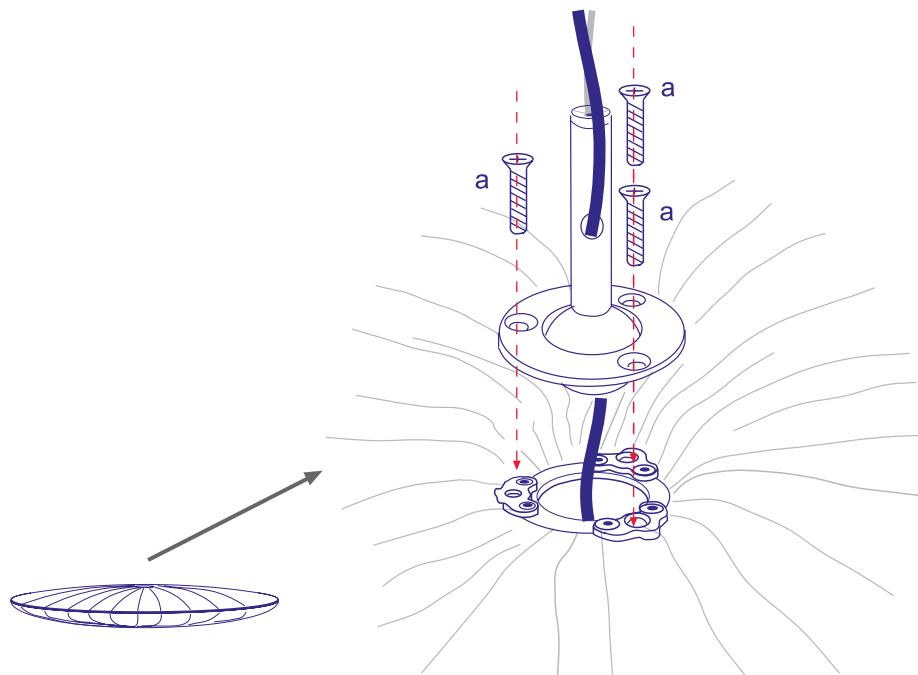

Aqua Creations Lighting & Furniture Atelier

Hanging Instructions Stand By Pendant

Lift cover plate and suspension cover upwards (drawing E) and close the suspension cover on the suspension element (drawing F). The suspension cover's shoulders support the cover plate.

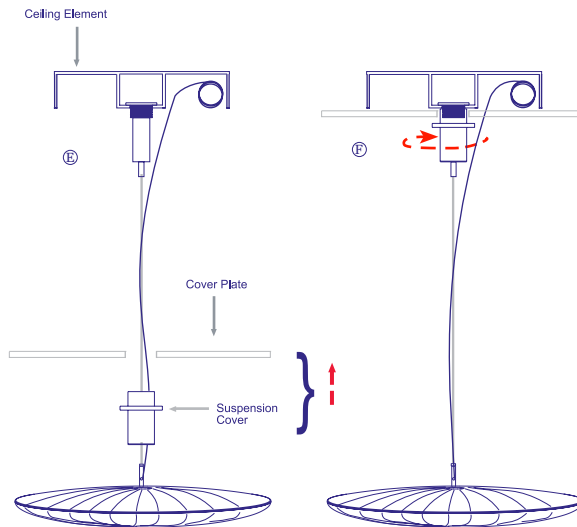

The lamp is hung leveled by default (position A). If you wish to install the shade on an angle, tilt the lamp to the desired position (position B) and then tighten the 3 screws as marked in figure 1 to lock the position.

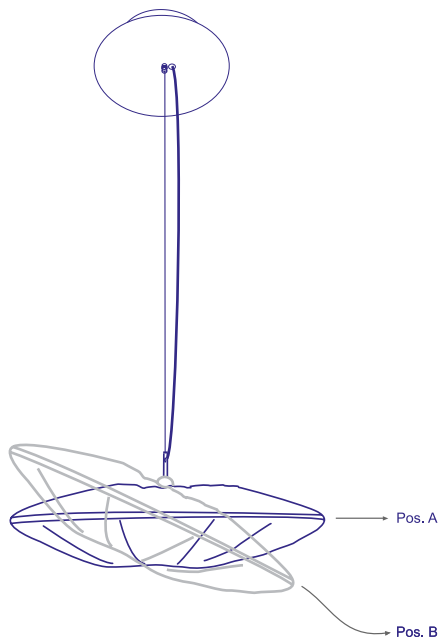

Aqua Creations Lighting & Furniture Atelier

Bulb Changing Instructions Stand By Pendant

