





The sizes are expressed in millimeters.

DESIGN DAVIDE GROPPI - 2005
LAMPADA A SOSPENSIONE - CARTA GIAPPONESE - PE
SUSPENSION LAMP - JAPANESE PAPER - PE

CE IP 20

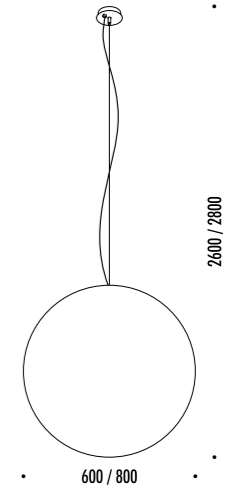
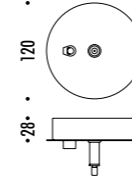
CEILING ROSE





151500	STANDARD	MOON 60 100-240 V - 50/60 Hz - MAX 105 W - E27 CAVO BIANCO - ROSONE BIANCO - LAMPADINA LED INCLUSA ACCESSORI OPZIONALI KIT SOSPENSIONE WHITE CABLE - WHITE CEILING ROSE - LED BULB INCLUDED OPTIONAL ACCESSORIES SUSPENSION KIT
		 13 W LED - 2700K - 1521 lm - CRI 90 - DIMMABLE - EFFICIENCY A+
137200	STANDARD	MOON 80 100-240 V - 50/60 Hz - MAX 105 W - E27 CAVO BIANCO - ROSONE BIANCO - LAMPADINA LED INCLUSA ACCESSORI OPZIONALI KIT SOSPENSIONE WHITE CABLE - WHITE CEILING ROSE - LED BULB INCLUDED OPTIONAL ACCESSORIES SUSPENSION KIT
		 13 W LED - 2700K - 1521 lm - CRI 90 - DIMMABLE - EFFICIENCY A+

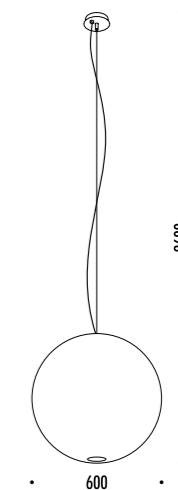
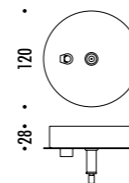

CEILING ROSE



165700	STANDARD	100-240 V - 50/60 Hz - MAX 23 W - E27 + MAX 10 W - GU10 CAVO TRASPARENTE - ROSONE BIANCO DOPPIA EMISSIONE - LAMPADINE LED INCLUSE ACCESSORI OPZIONALI KIT SOSPENSIONE TRANSPARENT CABLE - WHITE CEILING ROSE DUAL EMISSION - LED BULBS INCLUDED OPTIONAL ACCESSORIES SUSPENSION KIT
		 13 W LED - E27 - 2700K - 1521 lm - CRI 90 - DIMMABLE - EFFICIENCY A+
		 5,5 W LED - GU10 - 3000K - 375 lm - CRI 97 - DIMMABLE - EFFICIENCY A+





DESIGN DAVIDE GROPPI - 2005
 LAMPADA A SOSPENSIONE - CARTA GIAPPONESE - PE
 SUSPENSION LAMP - JAPANESE PAPER - PE

CE IP 20

MOON 120 / MOON 200

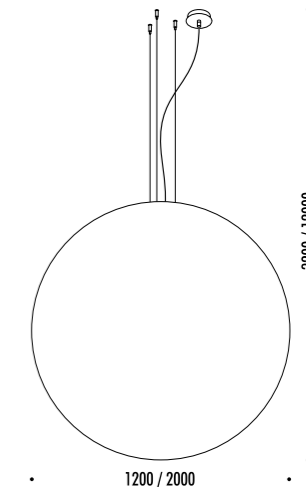
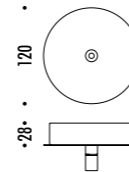





CEILING ROSE



198600	STANDARD	<p>MOON 120 100-240 V - 50/60 Hz - MAX 2 x 57 W - E27 CAVO BIANCO - ROSONE BIANCO - LAMPADINE LED INCLUDE ACCESSORI OPZIONALI KIT SOSPENSIONE WHITE CABLE - WHITE CEILING ROSE - LED BULBS INCLUDED OPTIONAL ACCESSORIES SUSPENSION KIT</p> <p> 2 x 21 W LED - 2700K - 2 x 2452 lm - CRI ≥80 - DIMMABLE - EFFICIENCY A+</p>
187800	STANDARD	<p>MOON 200 100-240 V - 50/60 Hz - MAX 4 x 25 W - E27 CAVO BIANCO - ROSONE BIANCO - LAMPADINE LED INCLUDE IMBALLO E TRASPORTO ESCLUSI WHITE CABLE - WHITE CEILING ROSE - LED BULBS INCLUDED PACKAGING AND DELIVERY EXCLUDED</p> <p> 4 x 13 W LED - 2700K - 4 x 1521 lm - CRI 90 - DIMMABLE - EFFICIENCY A+</p>

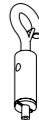

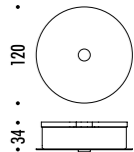
ACCESSORI OPZIONALI / OPTIONAL ACCESSORIES

1A05100	STANDARD	KIT FISSAGGIO PER SOFFITTO INCLINATO / SLOPED CEILING FIXING KIT COMPATIBLE LAMPS: QuiQuoQua - MASAI - FOSBURY - MOON 120 - SPY - BLADE	
1A05200	STANDARD	KIT FISSAGGIO PER ROSONE INCLINATO / SLOPED ROSE FIXING KIT COMPATIBLE LAMPS: MOON 60 - MOON 60 DE - MOON 80	
1A05300	STANDARD	GANCIO PER SOFFITTO INCLINATO / SLOPED CEILING FIXING HOOK COMPATIBLE LAMPS: MERIDIANA - SIMBIOSI - SHANGHAI	
1A03600	STANDARD	KIT DECENTRATORE / DECENTRALIZATION KIT COMPATIBLE LAMPS: LED IS MORE - MISS 1 - MOON 60 - MOON 60 DE - MOON 80 - MOON 120 CATHODE	
1A07703	BIANCO OPACO / MATT WHITE	KIT ROSONE + DECENTRATORE / KIT CEILING ROSE + DECENTRALIZER CAVO BIANCO 3 m INCLUSO / 3 m WHITE CABLE INCLUDED	 <p>• 120 • • 34 •</p>
1A07704	NERO OPACO / MATT BLACK	KIT ROSONE + DECENTRATORE / KIT CEILING ROSE + DECENTRALIZER CAVO NERO 3 m INCLUSO / 3 m BLACK CABLE INCLUDED	
172703	BIANCO OPACO / MATT WHITE	BLOCCACAVO / CLAMP	
172704	NERO OPACO / MATT BLACK		

1A05100 - KIT FISSAGGIO PER SOFFITTO INCLINATO / SLOPED CEILING FIXING KIT

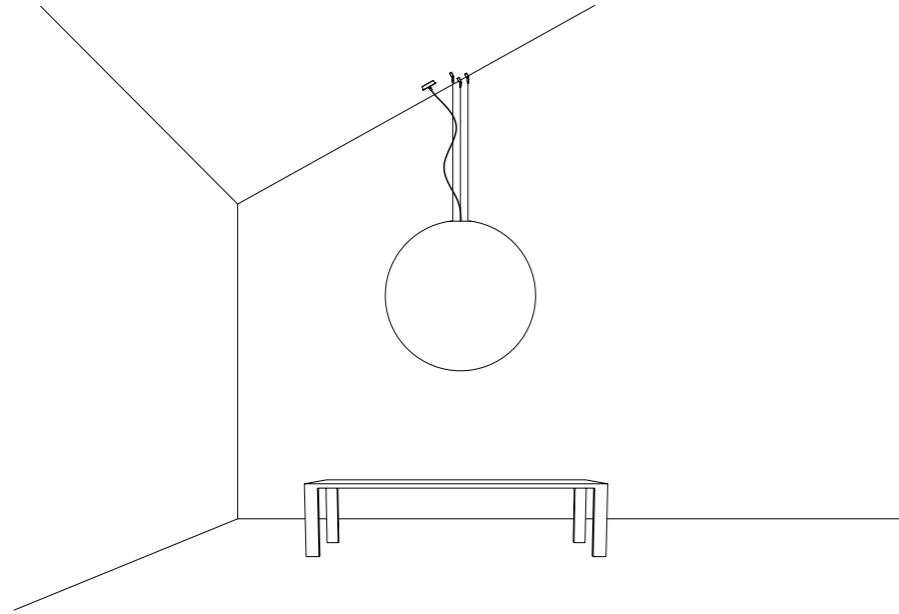

1A05300 - GANCIO PER SOFFITTO INCLINATO / SLOPED CEILING FIXING HOOK

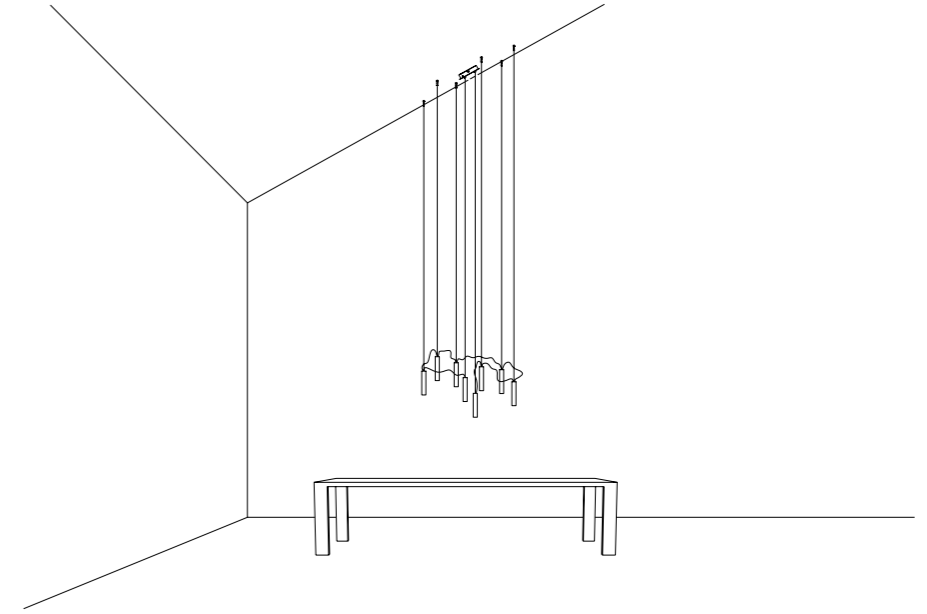

1A05200 - KIT FISSAGGIO PER ROSONE INCLINATO / SLOPED ROSE FIXING KIT

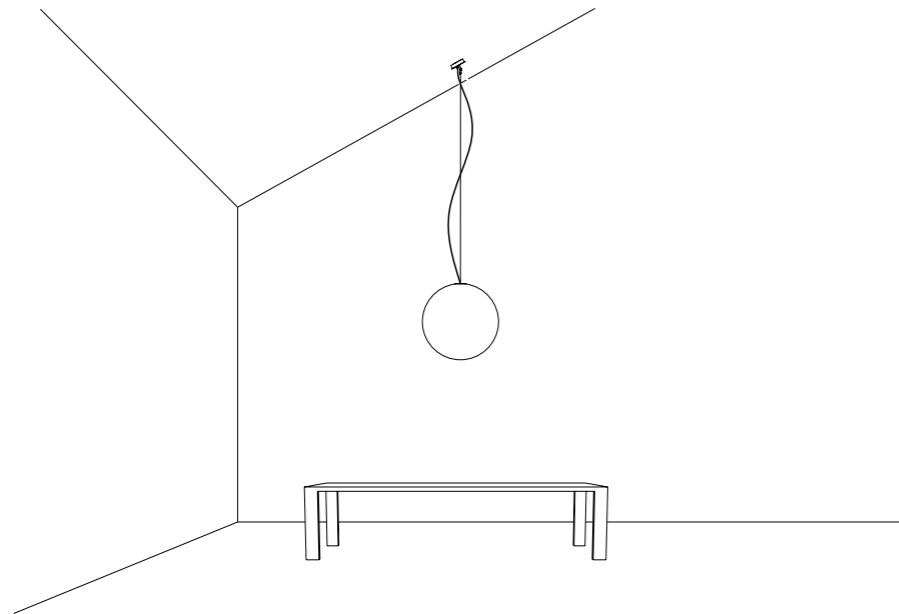

1A07703 / 1A07704 - KIT ROSONE + DECENTRATORE / KIT CEILING ROSE + DECENTRALIZER | 1A03600 KIT DECENTRATORE / DECENTRALIZATION KIT

