

Bugia,
design by Studio Italia Design, 2016

Ceiling

Round, compact forms featuring elegant finishes with a centre that shines like a precious stone. Once lit up, Bugia amazes with the unexpected effect of its light. A surprising and harmonious balance between direct and indirect light, diffused both downward and up toward the ceiling. A rich family of ceiling lights, in Single, Double, Triple and now also Mega versions.



Bugia Single	Light source	Frame Metal	Diffuser: Methacrylate	Code
	LED • 3000 K • 1 x 15W 1155 lm • 220-240V • CRI 90 • MacAdam 3-Step LED and driver included	● Matte White 9010	Glossy Copper	161032
		● Matte White 9010	Chrome	161031
		● Matte White 9010	Gold	161030
		● Matte White 9010	● White	161029
	LED • 2700 K • 1 x 15W 1092 lm • 220-240V • CRI 90 • MacAdam 3-Step LED and driver included	● Matte White 9010	Glossy Copper	161028
		● Matte White 9010	Chrome	161027
		● Matte White 9010	Gold	161026
		● Matte White 9010	● White	161025

Net weight: 0.80 kg	Gross weight: 1.52 kg	Parcels: N°2	Volume: 0.017 m³
---------------------	-----------------------	--------------	------------------

LODES

Bugia Double

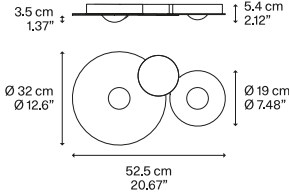

Light source

- LED
- 3000 K
- 2 x 15W | 2310 lm
- 220-240V
- CRI 90
- MacAdam 3-Step

LED and driver included

- LED
- 2700 K
- 2 x 15W | 2184 lm
- 220-240V
- CRI 90
- MacAdam 3-Step

LED and driver included

Frame Metal

● Matte White 9010

● Matte White 9010

● Matte White 9010

● Matte White 9010

● Matte White 9010

● Matte White 9010

● Matte White 9010

● Matte White 9010

Diffuser: Methacrylate

● Glossy Copper

|| Chrome

● Gold

● White

● Glossy Copper

|| Chrome

● Gold

● White

Code

161040

161039

161038

161037

161036

161035

161033

161033

Net weight: 2.05 kg

Gross weight: 4.91 kg

Parcels: N°2

Volume: 0.062 m³



IP20

Energy Saving

Dim Triac

Bugia Triple

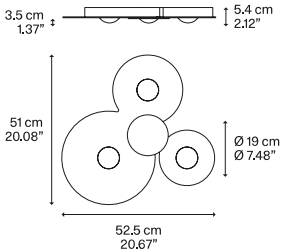

Light source

- LED
- 3000 K
- 3 x 15W | 3465 lm
- 220-240V
- CRI 90
- MacAdam 3-Step

LED and driver included

- LED
- 2700 K
- 3 x 15W | 3276 lm
- 220-240V
- CRI 90
- MacAdam 3-Step

LED and driver included

Frame Metal

● Matte White 9010

● Matte White 9010

● Matte White 9010

● Matte White 9010

● Matte White 9010

● Matte White 9010

● Matte White 9010

● Matte White 9010

Diffuser: Methacrylate

● Glossy Copper

|| Chrome

● Gold

● White

● Glossy Copper

|| Chrome

● Gold

● White

Code

161048

161047

161046

161045

161044

161043

161042

161041

Net weight: 2.80 kg

Gross weight: 5.66 kg

Parcels: N°2

Volume: 0.062 m³



IP20

Energy Saving

Dim Triac

Bugia Mega

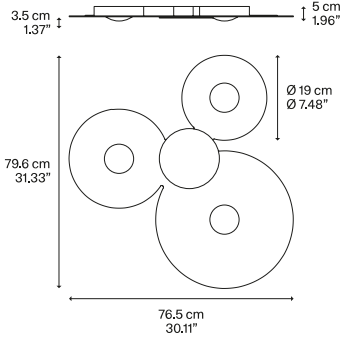

Light source

- LED
- 3000 K
 - 3 × 15W | 3825 lm
 - 220-240V
 - CRI 90
 - MacAdam 3-Step
- LED and driver included

- LED
- 2700 K
 - 3 × 15W | 3600 lm
 - 220-240V
 - CRI 90
 - MacAdam 3-Step
- LED and driver included

Frame Metal

- Matte White 9010
- Matte White 9010
- Matte White 9010
- Matte White 9010
- Matte White 9010
- Matte White 9010
- Matte White 9010
- Matte White 9010
- Matte White 9010
- Matte White 9010

Diffuser: Methacrylate

- Glossy Copper
- Chrome
- Gold
- White
- Glossy Copper
- Chrome
- Gold
- White

Code

- 161056
- 161055
- 161054
- 161053
- 161052
- 161051
- 161050
- 161049

Net weight: 4.40 kg

Gross weight: 8.80 kg

Parcels: N°2

Volume: 0.117 m³



IP20

Energy Saving

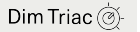

Polar diagram

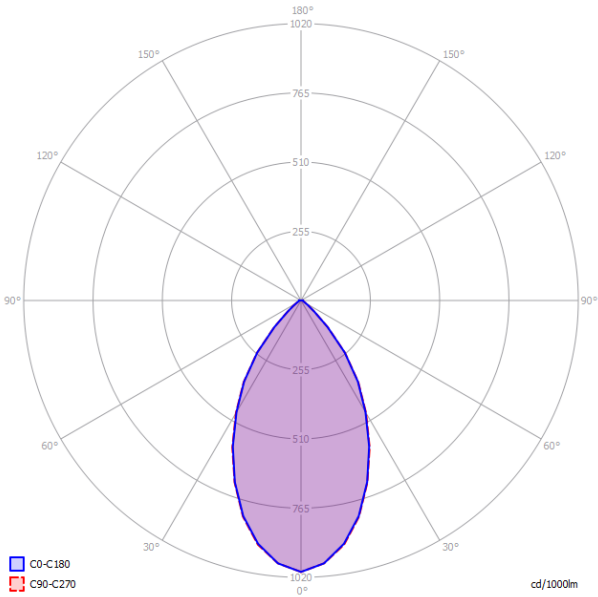

Bugia Single

- LED
- 3000 K
 - 3 × 15W | 3825 lm
 - 220-240V
 - CRI 90
 - MacAdam 3-Step
- LED and driver included

- LED
- 2700 K
 - 3 × 15W | 3600 lm
 - 220-240V
 - CRI 90
 - MacAdam 3-Step
- LED and driver included

LODES

Polar diagram

Bugia Double

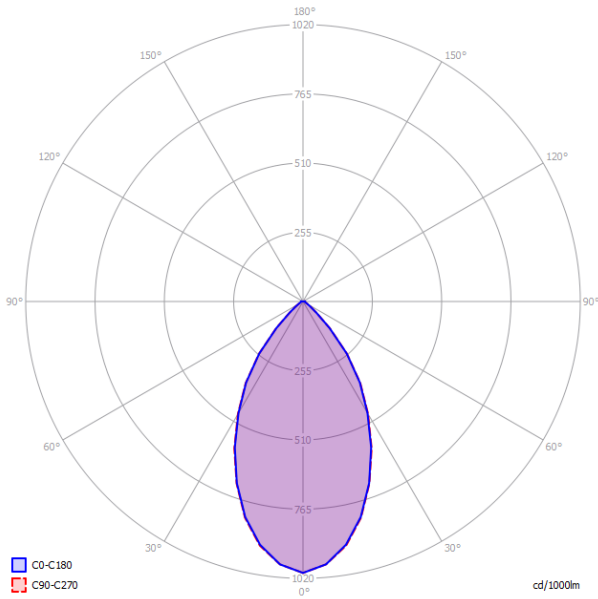

- LED
- 3000 K
 - 3 × 15W | 3825 lm
 - 220-240V
 - CRI 90
 - MacAdam 3-Step
- LED and driver included

- LED
- 2700 K
 - 3 × 15W | 3600 lm
 - 220-240V
 - CRI 90
 - MacAdam 3-Step
- LED and driver included

Polar diagram

Bugia Triple

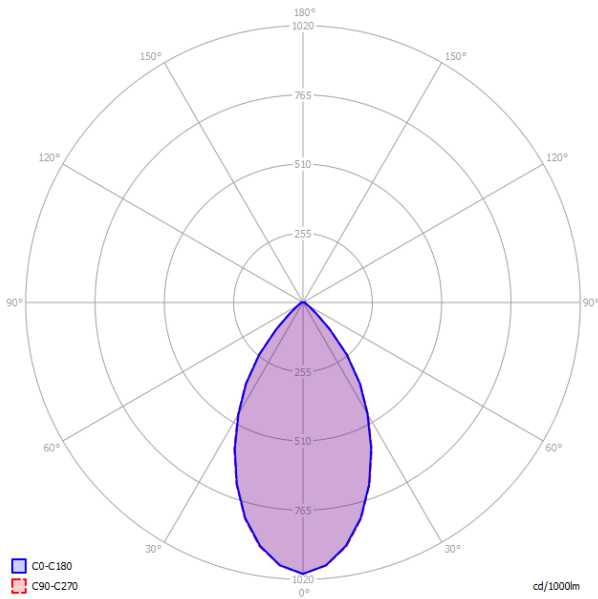

- LED
- 3000 K
 - 3 × 15W | 3825 lm
 - 220-240V
 - CRI 90
 - MacAdam 3-Step
- LED and driver included

- LED
- 2700 K
 - 3 × 15W | 3600 lm
 - 220-240V
 - CRI 90
 - MacAdam 3-Step
- LED and driver included