

ENOstudio

CIME

Pendant lamp - 2018



eno
studio

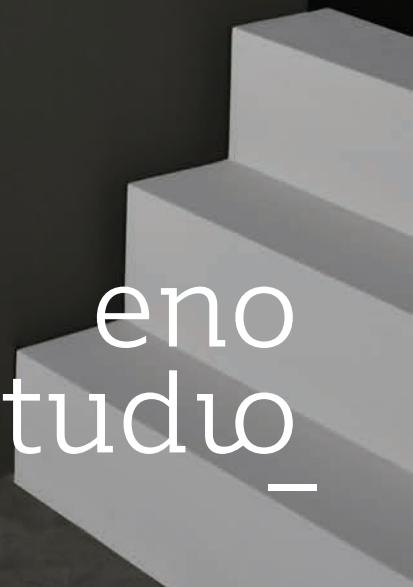

eno
studio
_



ENOstudio

CIME

Pendant lamp - 2018



Material & Finish

-  Brass
EN01EN009570
-  Opal 20cm
EN01EN009620
-  Opal 12cm
EN01EN009621

Verre soufflé, Acier laitoné /
Blown glass, steel brass

Dimensions & weight

Dimension / Size : 50x20 cm
Poids / Weight 3 kg
Câble / Cord : 3 m

Other details

Luminaire d'intérieur dimmable /
Indoor dimmable lamp only
IP20
G9 bulb not included

max 25 W
220-240 V
50 Hz

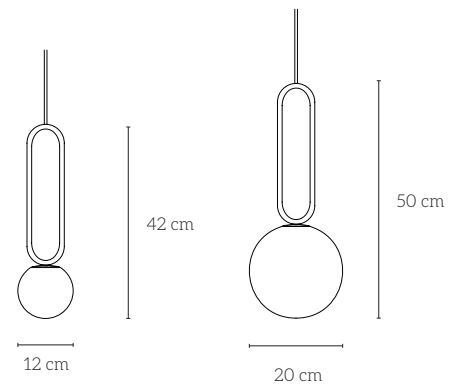

Entretien / Cleaning

Utiliser un chiffon doux et ne
pas utiliser de produit abrasif.

Use a clean and soft cloth. Do
not use any abrasive product.



ENOstudio

CIME

Table lamp - 2018



Material & Finish

-  Brass
EN01EN009550
-  Opal 20cm
EN01EN009600
-  Opal 12cm
EN01EN009601

Verre soufflé, Acier laitoné /
Blown glass, steel brass

Dimensions & weight

Dimension / Size : 50x20 cm
Poids / Weight 3 kg
Câble / Cord : 1,5 m

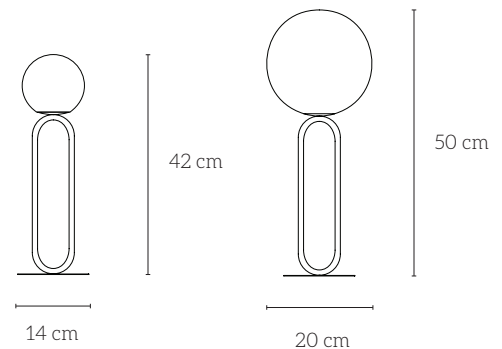

Other details

Luminaire d'intérieur dimmable /
Indoor dimmable lamp only
IP20
G9 bulb not included

max 25 W
220-240 V
50 Hz



Entretien / Cleaning

Utiliser un chiffon doux et ne
pas utiliser de produit abrasif.

Use a clean and soft cloth. Do
not use any abrasive product.



ENOstudio

CIME

Wall lamp - 2018



Material & Finish

-  Brass
EN01EN009560
-  Opal 20cm
EN01EN009610
-  Opal 12cm
EN01EN009611

Verre soufflé, Acier laitoné /
Blown glass, steel brass

Dimensions & weight

Dimension / Size :
Poids / Weight

50x20 cm
3 kg

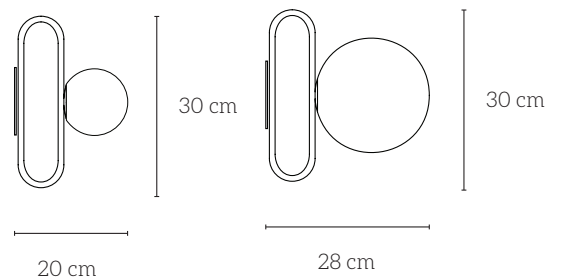

Other details

Luminaire d'intérieur dimmable /
Indoor dimmable lamp only
IP20
G9 bulb not included

max 25 W
220-240 V
50 Hz



Entretien / Cleaning

Utiliser un chiffon doux et ne
pas utiliser de produit abrasif.

Use a clean and soft cloth. Do
not use any abrasive product.

eno studio

ENO
studio

Editeur de design depuis plus de 10 ans, travaillant avec les plus talentueux designers actuel, il était donc normal que le studio ENO intègre en son sein une équipe de designer pour imaginer ses propres pièces. Nos réalisations vont de l'objet au mobilier en passant par le textile.

Design brand for 10 years, working with the most talented actual designers, it was obvious for ENO studio to incorporate a design team to imagine its own pieces. Our projects range from object to furniture and textile.



CIME

Lamp - 2018

«CIME, est une collection de luminaires qui se jouent de la gravité. Un globe en verre circule autour d'un anneau en laiton brossé, créant une rencontre entre formes simples et sophistication».

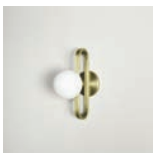

«CIME is a light collection which play with gravity. The glass globe seems to run around the brushed brass ring, creating a bound between simple shapes and sophistication».

Other editions by
ENOSTUDIO :

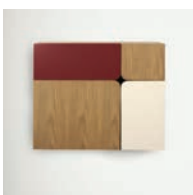

eno
studio
—

ENOstudio

Bureau & showroom

39 rue Sainte-Croix-de-la-Bretonnerie

75004 Paris

T +33 (0) 1 53 00 93 33

enostudio.fr