

TECHNICAL DATA SHEET

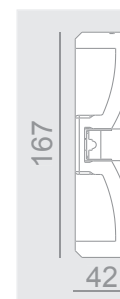
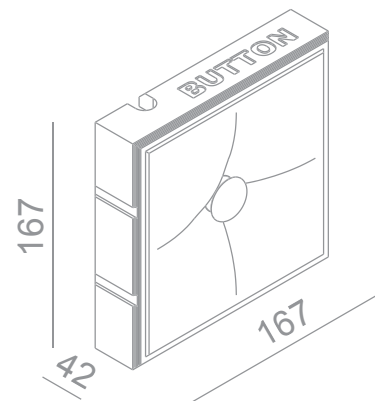

Ready for installation in solid walls
Optional plasterkit for installation into gypsum walls

PLASTERKIT BUTTON 1

REF N° 748 01 000 For mounting into gypsum walls

 175x175 mm. Housing: perforated aluminium

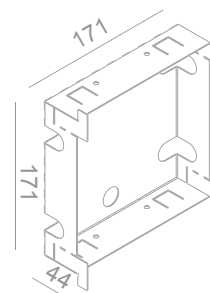









BUTTON 1 LED DIM

REF N° 148 60 500 CRI 80 warm white 2200°K

REF N° 148 60 000 CRI 90 warm white 2700°K

REF N° 148 60 100 CRI 90 warm white 3000°K

REF N° 148 60 300 royal blue



 - 1W - excl. LED driver - current controlled 350 mA -  -  -  -  - 
CE - IP40 -  -  -  - serial wiring
3 SDCM - 3 Step MacAdam
Requires remote LED driver
current controlled 350 mA

REMOTE LED DRIVER ON/OFF

REF N° 697 00 006 8W

REF N° 697 00 015 15W

REF N° 697 00 025 25W

230V/50Hz -  - current controlled
 - **CE** - IP20 - 350mA - not dimmable

REMOTE LED DRIVER DIM

REF N° 697 60 006 6W 1-10V

REF N° 697 60 015 15W 1-10V



REF N° 697 30 015 15W DALI

REF N° 697 60 025 25W 1-10V DALI PUSH

REF N° 697 60 040 40W 1-10V DALI PUSH

REF N° 697 70 009 9W PHASE DIM (tr. edge)

REF N° 697 70 017 17W PHASE DIM

230V/50Hz -  - current controlled
 - **CE** - IP20 - 350mA - dimmable