

Name: Tibeta - Set 3

Design: Christophe Mathieu / 2015

Typology: Pendant lamp









Environment: Indoor

Technical description:

3 pendant linear fixture. Each pendant is made of spun aluminum available in Black Chrome with Black Fabric Cable and Black Canopy, Brilliant Copper with Copper Mesh Cable and White Canopy or Polished Aluminum with Grey Fabric Cable and White Canopy. Each pendant houses an LED plate diffused through opal glass.



Lamps description

	Grounding: compulsory
	Ready for mounting on normally flammable surface
	TRIAC dimming system
	30,4 W LED Led: 30,4 W LED Lumens: 2155 lm CRI: 80 Degrees Kelvin: 2900 ^º -3200 ^º
Voltage: 230V~50Hz	
	1 Box 47 x 40 x 106 cm
Vol.: 0,1993 m ³	Weight: 17 kg
Certifications:  	
	Photometrics made according to the position the lights are shown in the catalogue and price list.

Ref	Finishings
2570420107	Black Chrome Black Fabric Wire Black Canopy
2570420164	Polished Aluminum Grey Fabric Wire White Canopy
2570420190	Brilliant Copper Copper Metallic Mesh White Canopy
TRIAC Dimmable	
Not Customizable	

Measures

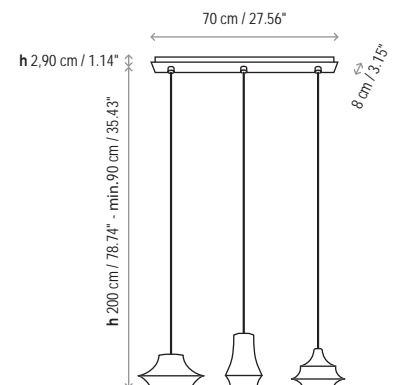

Tibeta - 01

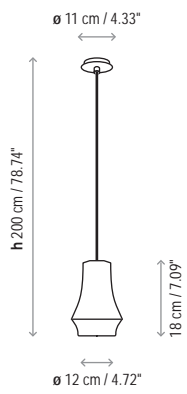

Tibeta - 02

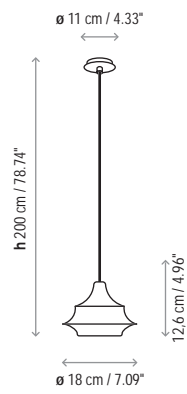

Tibeta - 03

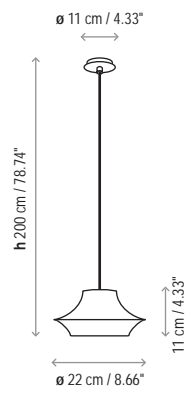

Tibeta - Set 3

