

Name: Syra - 60 Outdoor

Design: Alex Fernández Camps / Gonzalo Milà / 2014

Typology: Pendant lamp

Environment: Outdoor

Technical description:

Outdoor pendant lamp. LED light source protected by an opal matt glass plate. Shade is an aluminum structure that is hand wrapped with synthetic polyethylene fiber and is available in White or Chocolate. Canopy is coated with anticorrosive, cataphoresis treatment to provide protection against all weather conditions. Built in accordance with IP 55 rating. Electrical cord is sleeved with protective neoprene. Height can be adjusted by tensor stainless steel wires.



Lamps description

 Grounding: compulsory

 Ready for mounting on normally flammable surface

 22 W LED
Led: 66 x 0.33 W = 22 W
Lumens: 2500 lm
CRI: 90
Degrees Kelvin: 2700°

Voltage: 230V~50Hz

 1 Box 75 x 75 x 45 cm

Vol.: 0,2531 m³

Weight: 9 kg

Certifications:   IP-55

 Photometrics made according to the position the lights are shown in the catalogue and price list.

Ref Finishings

2640220158 White

2640220159 Chocolate Brown

Synthetic Polyethylene Fiber.
All Bover's synthetic fiber collection are recyclable and non-toxic for environmental sustainability.

Not Customizable

Measures

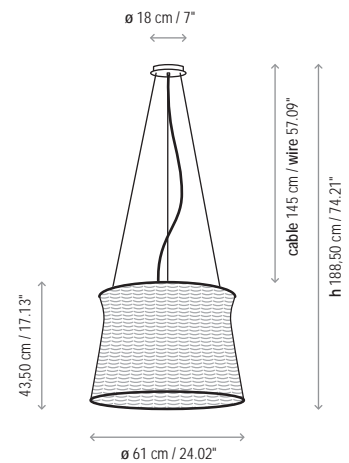

Syra - 45 Indoor

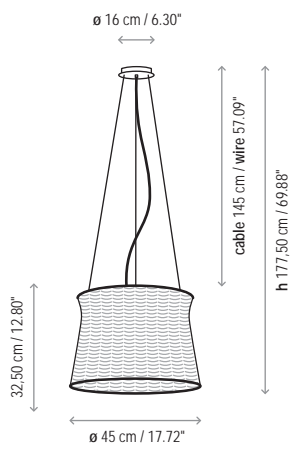

Syra - 60 Outdoor

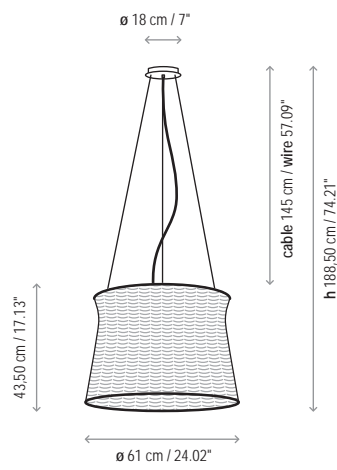

Syra - 90 Outdoor

