

Name: Slend - 03

Design: Christophe Mathieu / 2014

Typology: Pendant lamp

Environment: Indoor

Technical description:

Spun aluminum pendant available in 3 different shapes, each with finish options of Brilliant Black, Brilliant White or Polished Aluminum. Copper lined aperture houses direct light source from LED lamp. Height adjustable cable in transparent for Polished Aluminum, white for Brilliant White fixtures or black for Brilliant Black fixtures.



Lamps description

 Grounding: excluded

 Ready for mounting on normally flammable surface

 1 x 6 W GU10 LED

Voltage: 230V~50Hz

 1 Box 79 x 16 x 14 cm

Vol.: 0,0177 m³

Weight: 3 kg

Certifications:  

 Photometrics made according to the position the lights are shown in the catalogue and price list.

Ref	Finishings
2560320064	Polished Aluminum Chrome Canopy Transparent Wire
2560320001	Brilliant White White Canopy White Wire
2560320023	Brilliant Black Black Canopy Black Wire

Matte finish available (please consult)

Special colors: RAL number to be indicated. Minimum quantity: 5 pieces.

Adjustable height by the user

LED bulb included

Not Customizable

Measures

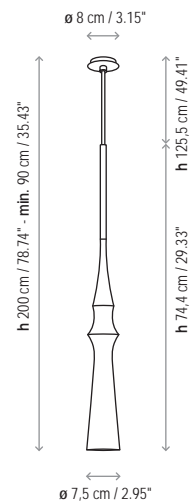

Slend - 01

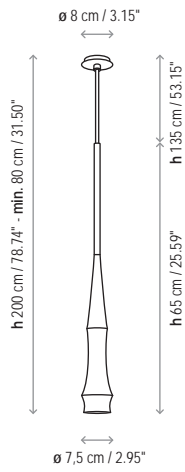

Slend - 02

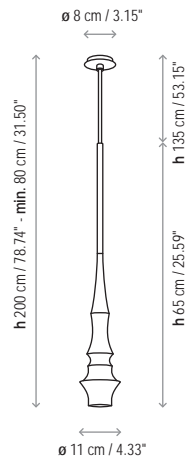

Slend - 03

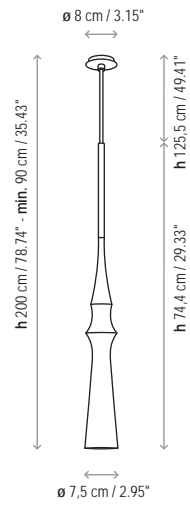

Slend - Set 3 Round

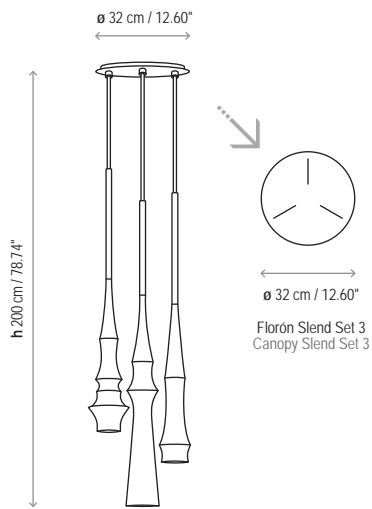

Slend - Set 3 Lineal

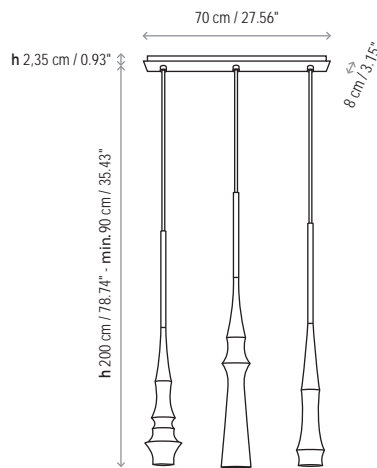

Slend - Set 6

