

Name: Nón Lá S

Design: Jorge Pensi Design Studio / 2015

Typology: Pendant lamp









Environment: Indoor

Technical description:

Lightweight asymmetrically stemmed conical LED pendant made of aluminum finished in Chrome, Copper, White and Black lacquer. Polycarbonate diffuser covering LED panel. Adjustable transparent electrical cable. Dimming system: TRIAC.



Lamps description

	Grounding: compulsory
	Ready for mounting on normally flammable surface
	TRIAC dimming system
	10,5 W LED Led: 35 x 0,3 W = 10,5 W Lumens: 1200 lm CRI: 90 Degrees Kelvin: 2700 <sup>a</sup>
Voltage: 230V~50Hz	
	1 Box 22 x 22 x 39 cm
Vol.: 0,0188 m <sup>3</sup>	Weight: 1,86 kg
Certifications:  	
	Photometrics made according to the position the lights are shown in the catalogue and price list.

Ref Finishings

3320120101	White Brilliant Lacquer White Canopy White Wire
3320120106	Chrome White Canopy Transparent Wire
3320120123	Black Brilliant Lacquer Black Canopy Black Wire
3320120190	Brilliant Copper Black Canopy Black Wire
3320120401	Triac White Brilliant Lacquer White Canopy White Wire
3320120406	Triac Chrome White Canopy Transparent Wire
3320120423	Triac Black Brilliant Lacquer Black Canopy Black Wire
3320120490	Triac Brilliant Copper Black Canopy Black Wire

Measures

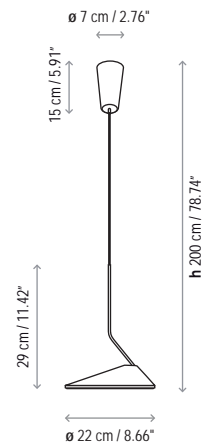

Adjustable shade / Aluminium hood

Not Customizable

Nón Lá A 01

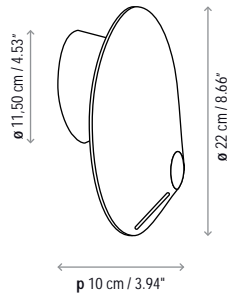

Nón Lá A 02

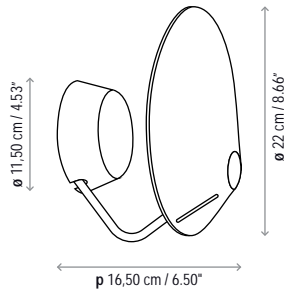

Nón Lá A 03

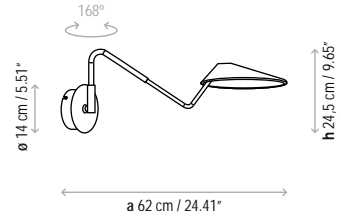

Nón Lá A 04

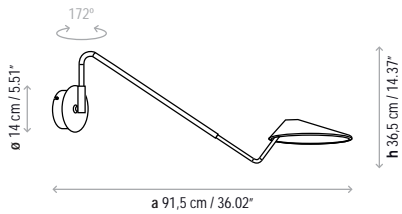

Nón Lá T

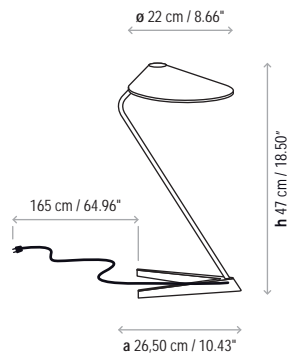

Nón Lá S

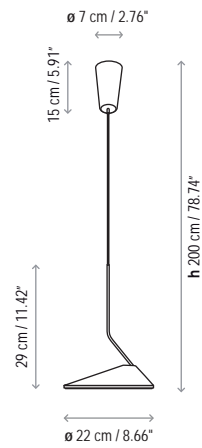

Nón Lá Set 3 Circular

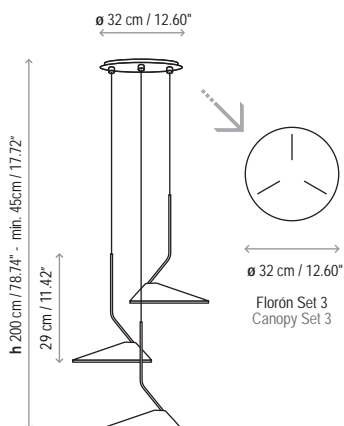

Nón Lá Set 3 Rectangular

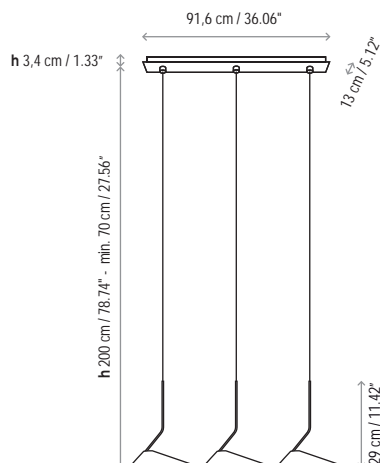

Nón Lá Set 6 Circular

