

Name: Nón Lá A 01

Design: Jorge Pensi Design Studio / 2015

Typology: Wall lamp

Environment: Indoor

Technical description:









Lightweight asymmetrical conical LED wall sconce made of aluminum finished in Chrome, Copper, White and Black lacquer. Polycarbonate diffuser covering LED panel. Light reflects on wall as well as through the aperture and slot on the shade. Meets ADA standards.

Can be ceiling mounted.

Dimming system: Triac.



Lamps description

	Grounding: compulsory
	Ready for mounting on normally flammable surface
	TRIAC dimming system
	10,5 W LED Led: 35 x 0,3 W = 10,5 W Lumens: 1200 lm CRI: 90 Degrees Kelvin: 2700º
Voltage: 230V~50Hz	
	1 Box 27 x 27 x 25 cm
Vol.: 0,0182 m ³ Weight: 1,82 kg	
Certifications:  	
	Photometrics made according to the position the lights are shown in the catalogue and price list.

Ref Finishings

3320100601	White Brilliant Lacquer
3320100606	Chrome
3320100623	Black Brilliant Lacquer
3320100690	Brilliant Copper
3320101101	Triac White Brilliant Lacquer
3320101106	Triac Chrome
3320101123	Triac Black Brilliant Lacquer
3320101190	Triac Brilliant Copper
Not Customizable	

Measures

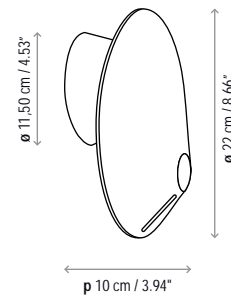

Nón Lá A 01

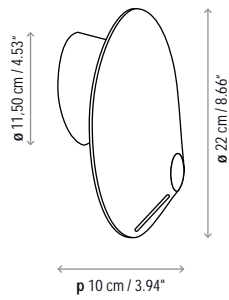

Nón Lá A 02

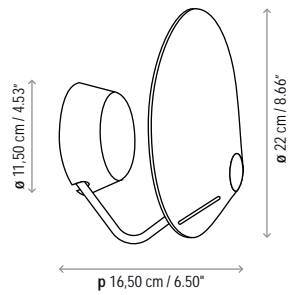

Nón Lá A 03

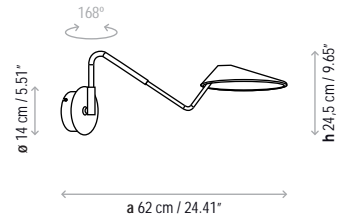

Nón Lá A 04

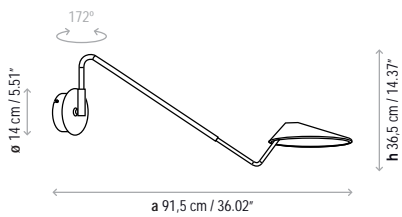

Nón Lá T

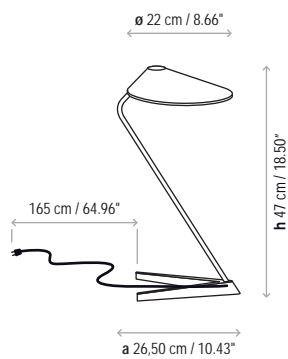

Nón Lá S

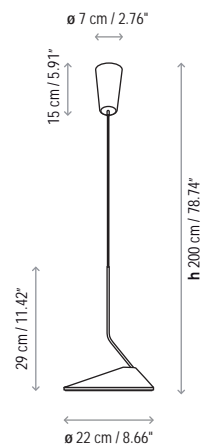

Nón Lá Set 3 Circular

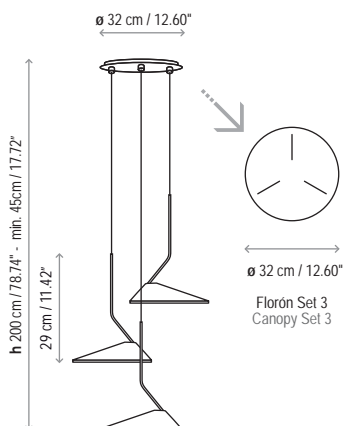

Nón Lá Set 3 Rectangular

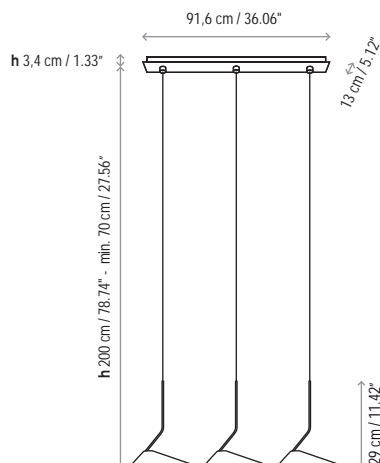

Nón Lá Set 6 Circular

