

Name: Maxi - P

Design: Joana Bover / 2004

Typology: Floor lamp

Environment: Outdoor

Technical description:

Outdoor floor lamp with sealed, nonporous polyethylene shade housing two T5 florescent bulbs. Available with secure floor base, allowing for fastening to the floor by removing rubber stoppers on base. Electrical cables have propylene coating to respect IP 55 rating.

Polyethylene shade is available only in white. Not customizable. No electrical switch mounting allowed on cable or fixture. (IP 55).

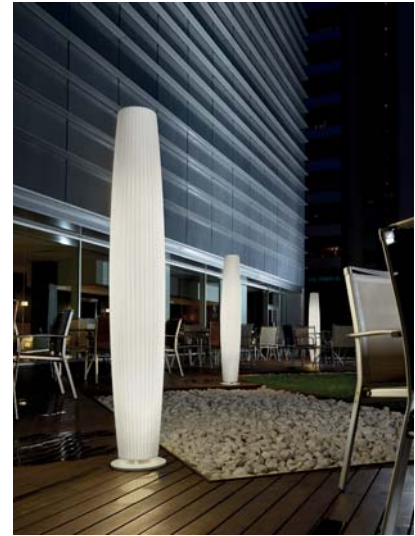

Lamps description

 Grounding: compulsory

 2 x 28 W T5 HE

 2 x 54 W T5 HO

Voltage: 230V~50Hz

 1 Box 34 x 35 x 200 cm

Vol.: 0,2380 m<sup>3</sup>

Weight: 18 kg

Certifications:   IP-55

 Photometrics made according to the position the lights are shown in the catalogue and price list.

Ref      Finishings

3229500    White

Supply fluorescent tubes (2x28W) already installed inside the luminaire.

Light source is protected by a Polyethylene shade (Operating temperature: -40°C to +70°C)

Fixing on the floor:  
The floor lamp can be fixed by removing the rubber stoppers placed on the foot base.

Fixing on the surface with built-in wire:  
In this case, wire should be made out of rubber type HO5RN or superior, with a diameter between 6 and 8 mm.

Not Customizable

Measures

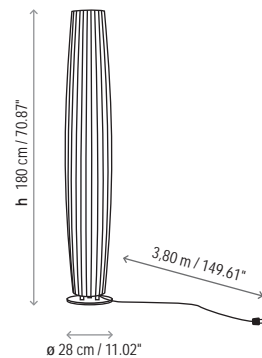

Maxi - 01 Floor

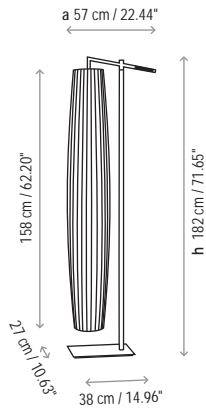

Maxi - 02 Floor

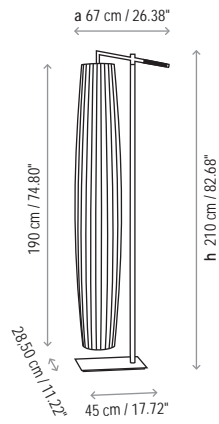

Maxi - 03 Floor

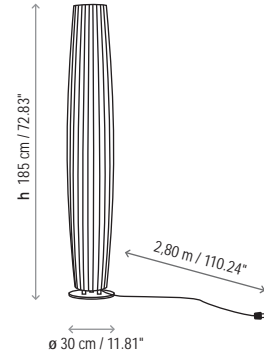

Maxi - 01 Pendant Lamp

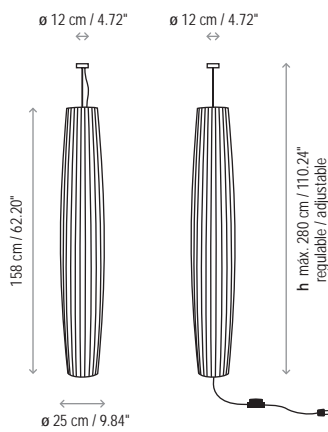

Maxi - 02 Pendant Lamp

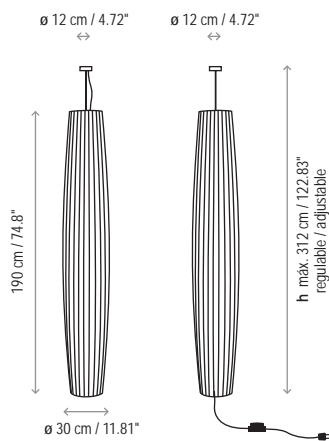

Maxi - 03 / Dimable Pendant Lamp

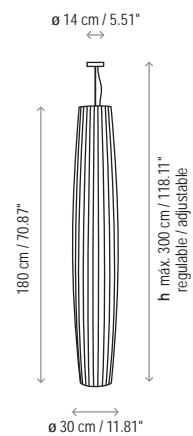

Maxi - P Outdoor

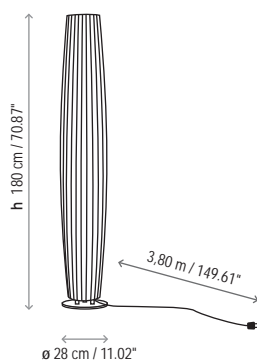

Maxi - S Outdoor

