

Name: Maxi - 02

Design: Joana Bover / 2004

Typology: Pendant lamp









Environment: Indoor

Technical description:

Pendant lamp with hand wrapped translucent polyester blend ribbon with an internal iron frame. Available with electrical installation from above or below. The Maxi can be ordered with white or cream translucent ribbon, with additional colors available for special orders. Various tensor wires are available: 1.5, 3, and 5 mt + terminal.



Lamps description

-  Grounding: excluded
-  Ready for mounting on normally flammable surface
-  4 x 46 W Classic P Eco E-27
-  4 x 30 W E-27
- Voltage: 230V~50Hz
-  1 Box 34 x 35 x 200 cm
- Vol.: 0,2380 m³
- Weight: 7 kg
- Certifications:  
-  Photometrics made according to the position the lights are shown in the catalogue and price list.

Ref Finishings

- 44195TOP Electrical Upper Installation
- 4419505 Electrical Bottom Installation
- Lampshade 190 X 30 cm
- P-506T Top Cream Ribbon
- P-509T Top White Ribbon
- P-506I Bottom Inst. Cream Ribbon
- P-509I Bottom Inst. White Ribbon
- Adjustable tensor wire
- Nickel canopy (only for upper installation)
- Eco Classic bulbs included
- Maxi 01 / Maxi 02 pendant lamp comes in two versions: with upper installation and with bottom installation.
- Customizable

Measures

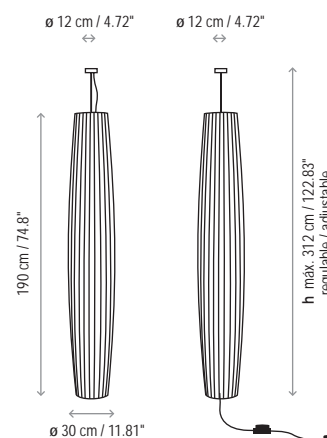

Maxi - 01 Floor

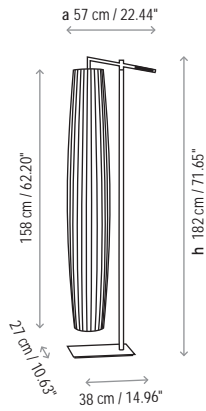

Maxi - 02 Floor

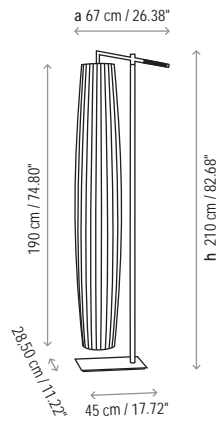

Maxi - 03 Floor

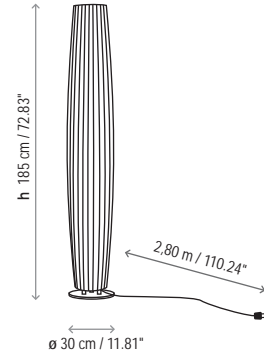

Maxi - 01 Pendant Lamp

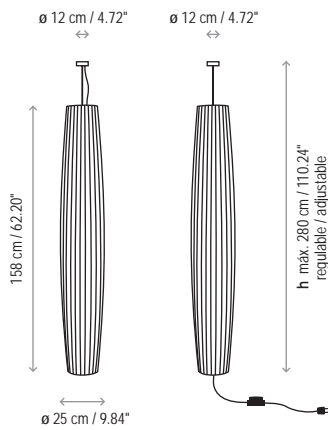

Maxi - 02 Pendant Lamp

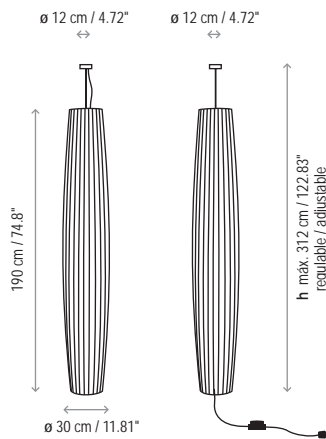

Maxi - 03 / Dimable Pendant Lamp

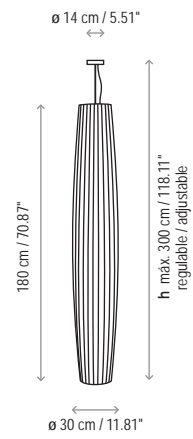

Maxi - P Outdoor

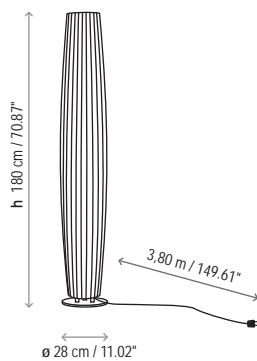

Maxi - S Outdoor

