

Name: Lineana - V

Design: Christophe Mathieu / 2010

Typology: Wall lamp





Environment: Outdoor

Technical description:

Exterior wall sconce with LED light emitting from polycarbonate diffuser. Structure and slotted mask made of stainless steel and aluminum with a brown or grey graphite paint finish.



Lamps description

-  Grounding: compulsory
-  Ready for mounting on normally flammable surface
-  2 x 9 W G9 Bajo consumo
-  2 x 3,5 W LED G-9
-  26 W LED  
Led: 26 W  
Lumens: 1880 lm  
CRI: 80  
Degrees Kelvin: 3000<sup>a</sup>

Voltage: 230V~50Hz

 1 Box 25 x 65 x 15 cm

Vol.: 0,0244 m<sup>3</sup>

Weight: 3 kg

Certifications:  IP-55

 Photometrics made according to the position the lights are shown in the catalogue and price list.

| Ref                          | Finishings           |
|------------------------------|----------------------|
| 1121208V                     | Grey Graphite (G9)   |
| 1121203V                     | Brown Graphite (G9)  |
| 1121208LV                    | Grey Graphite (LED)  |
| 1121203LV                    | Brown Graphite (LED) |
| Surface back box: 14 x 31 cm |                      |
| Not Customizable             |                      |

Measures

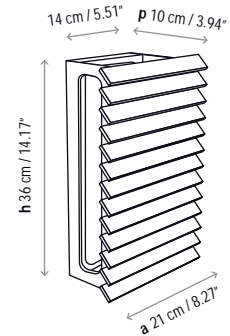

Lineana - H

---

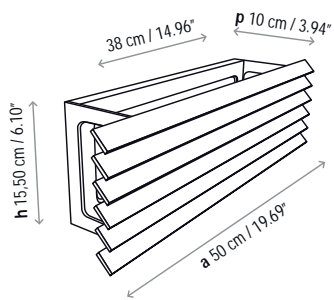

Lineana - V

---

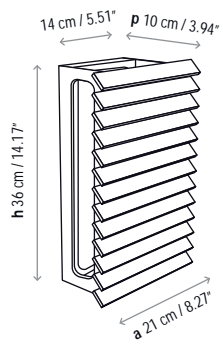

Lineana - Ipe

---

