

Name: Lineana - H

Design: Christophe Mathieu / 2010

Typology: Wall lamp









Environment: Outdoor

Technical description:

Exterior wall sconce with LED light emitting from polycarbonate diffuser. Structure and slotted mask made of stainless steel and aluminum with a brown or grey graphite paint finish.



Lamps description

	Grounding: compulsory
	Ready for mounting on normally flammable surface
	2 x 9 W G9 Bajo consumo
	2 x 3,5 W LED G-9
	26 W LED Led: 26 W Lumens: 1880 lm CRI: 80 Degrees Kelvin: 3000 ^a
Voltage: 230V~50Hz	
	1 Box 25 x 65 x 15 cm
Vol.: 0,0244 m ³	
Weight: 3 kg	
Certifications:  IP-55	
	Photometrics made according to the position the lights are shown in the catalogue and price list.

Ref	Finishings
1121208H	Grey Graphite (G9)
1121203H	Brown Graphite (G9)
1121208LH	Grey Graphite (LED)
1121203LH	Brown Graphite (LED)
Surface back box: 38 x 15 cm	
Not Customizable	

Measures

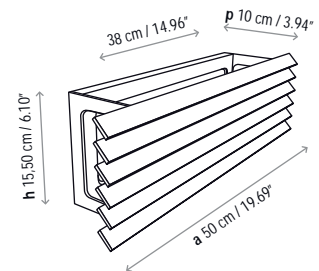

Lineana - H

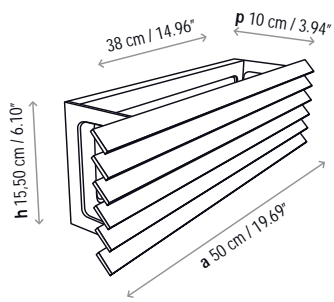

Lineana - V

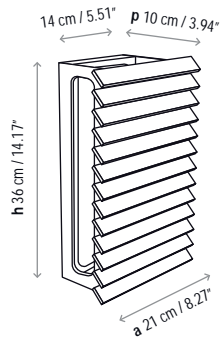

Lineana - Ipe

