

Name: Lua - 1 Luz

Design: Joana Bover / 2002

Typology: Pendant lamp

Environment: Indoor

Technical description:









Pendant lamp with extendable structure in black iron, satin nickel, nickel with dark leather, or nickel with caramel leather.

Diffused light through cotton shade, or hand wrapped polyester ribbon in either white or cream.

Upper diffuser included.



Lamps description

	Grounding: compulsory
	Ready for mounting on normally flammable surface
	2 x 77 W Classic A Eco E-27
	2 x 18 W E-27
Voltage: 230V~50Hz	
	1 Box 67 x 67 x 27 cm
Vol.: 0,1212 m ³	
Weight: 5 kg	
Certifications:  	
	Photometrics made according to the position the lights are shown in the catalogue and price list.

Ref Finishings

4122904	Black Iron
4122905	Satin Nickel
4122960	Nickel Dark Leather
4122961	Nickel Caramel Leather
Lampshade 47 x 21 x 40 cm	
P-160C	Cotton
P-183C	Cream Translucent Ribbon
P-184C	White Translucent Ribbon
The shade includes upper diffuser	
Customizable	

Measures

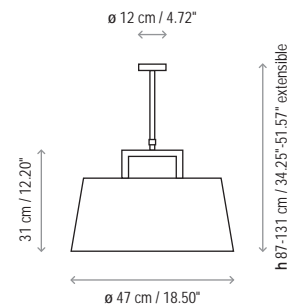

Lua - 1 Luz

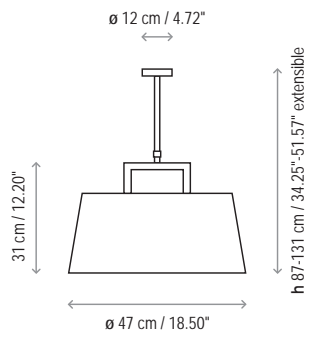

Lua - 2 Luces

