

Name: Elea - 85

Design: Joana Bover / 2013

Typology: Pendant lamp

Environment: Indoor

Technical description:

Polyurethane, circular pendant with a brilliant lacquer finish. Optical glass upper and lower diffusers are included. Upper glass diffuser has four decorative vents that stylishly maximize light diffusion. Canopy is cone-shaped, with custom drop capabilities. Available in two standard sizes, with three color options.

Elea is not a customizable product. For special finishings the RAL number is needed, and the minimum quantity is 3 units.

Lamps description

 Grounding: compulsory

 Ready for mounting on normally flammable surface

 4 x 55 W 2G11

Voltage: 230V~50Hz

 1 Box 90 x 90 x 25 cm

Vol.: 0,2025 m³

Weight: 24 kg

Certifications:  

 Photometrics made according to the position the lights are shown in the catalogue and price list.

Ref	Finishings
410332401	White Brilliant Lacquer
410332422	Red Brilliant Lacquer
410332423	Black Brilliant Lacquer
D410332401	Dali Dimming System White Brilliant Lacquer
D410332422	Dali Dimming System Red Brilliant Lacquer
D410332423	Dali Dimming System Black Brilliant Lacquer
Finishing: Brilliant lacquer finish	
Material: Polyurethane	
Optical glass diffuser	

Not Customizable



Measures

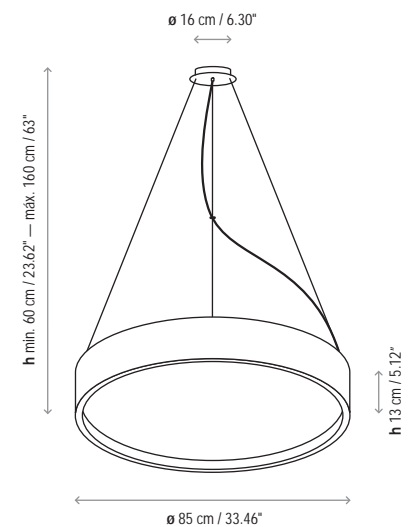

Elea - 55

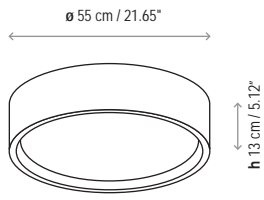

Elea - 85

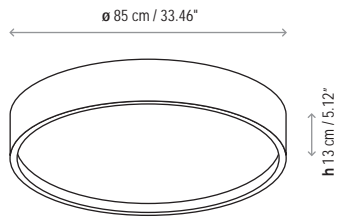

Elea - 55

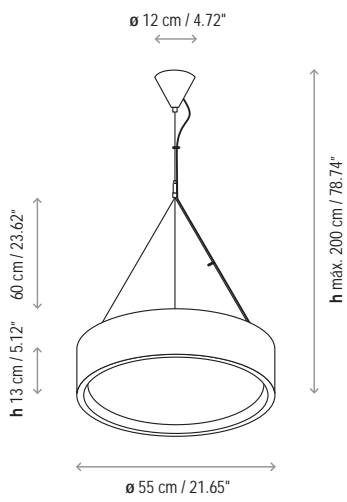

Elea - 85

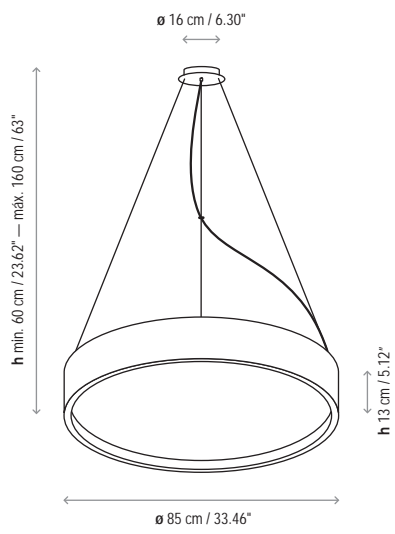

Elea - LP 95

