

Name: Amphora - 03

Design: Alex Fernández Camps / Gonzalo Milà / 2013

Typology: Floor lamp

Environment: Outdoor

Technical description:





Outdoor floor lamp made of aluminum with a tripod stand structure. Fixture has received an applied Cataphoresis treatment to help withstand exposure to the elements. Lamp shade is composed of hand wrapped polyethylene synthetic fiber, mounted on an aluminum frame, available in different colors. Light source is protected by a frosted, polyethylene globe of medium density and UV protection. Electrical cord is protected with water-proof neoprene coating, and

fixture is direct wire with no switch on the cord or fixture. Available in three sizes.



Amphora is not a customizable product. It can be securely fastened to the floor with surface wiring.



Lamps description

-  Grounding: compulsory
-  Ready for mounting on normally flammable surface
-  2 x 30 W E-27
-  2 x 8 W E-27 LED
- Voltage: 230V~50Hz

Optional

-  1 Box 93 x 93 x 147 cm  
Vol.: 1,2714 m<sup>3</sup> Weight: 32,5 kg
-  1 Wood box 100 x 100 x 163 cm  
Vol.: 1,63 m<sup>3</sup> Weight: 73 kg

Certifications:   IP-55

 Photometrics made according to the position the lights are shown in the catalogue and price list.

Ref	Finishings
0333003	Brown Graphite Structure
Lampshade 89 x 127 cm	
Synthetic Polyethylene Fiber (Operating temperature: -70°C to +70°C)	
P-747	Light Beige
P-748	Brown

All Bover's synthetic fiber collection are recyclable and non-toxic for environmental sustainability.

Light source is protected by polyethylene globe of medium density and UV protection.  
(Operating temperature: -40°C to +70°C)

Lamp and shade structure made in aluminium

Black wire without switch

Not Customizable. Please consult for special options.

Measures

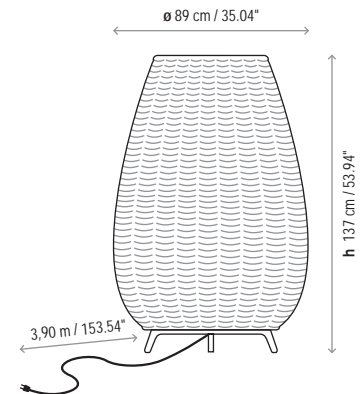

Amphora - 01

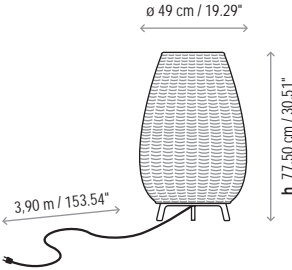

Amphora - 02

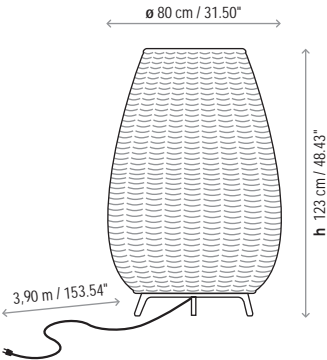

Amphora - 03

