

Name: Siam - 200

Design: Joana Bover / 2010

Typology: Ceiling lamp





Environment: Indoor

Technical description:

Ceiling lamp providing diffused light through a translucent shade composed of hand wrapped polyester blend ribbon, with structure finished in satin nickel or white, in two size options. Ribbon colors are available in white, cream and red. Frosted white methacrylate diffuser is included. This ceiling lamp can be mounted to be partially superimposed upon themselves to create stylish combinations according to the clients' needs.





Lamps description

-  Grounding: compulsory
-  Ready for mounting on normally flammable surface
-  8 x 46 W Classic P Eco E-27
-  8 x 30 W E-27

Voltage: 230V~50Hz

2 Boxes:

-  1 Box 210 x 45 x 215 cm  
Vol.: 2,0318 m<sup>3</sup> Weight: 45 kg
-  1 Box 215 x 55 x 220 cm  
Vol.: 2,6015 m<sup>3</sup> Weight: 125 kg

Certifications:  

 Photometrics made according to the position the lights are shown in the catalogue and price list.

| Ref      | Finishings                   |
|----------|------------------------------|
| 0332005P | Structure 185 - Satin Nickel |
| 0332001P | Structure 185 - White 9010   |
| 0332005G | Structure 430 - Satin Nickel |
| 0332001G | Structure 430 - White 9010   |

Lampshade:

|        |                          |
|--------|--------------------------|
| P-690C | White Translucent Ribbon |
| P-691C | Cream Translucent Ribbon |
| P-692C | Red Translucent Ribbon   |

This ceiling lamp allows several individual or group compositions. Available in two sizes: 18,5 cm and 43 cm structure.

Superimposing shades partially, one on another, we will obtain a mural suitable for each space and need.

Customizable

Measures

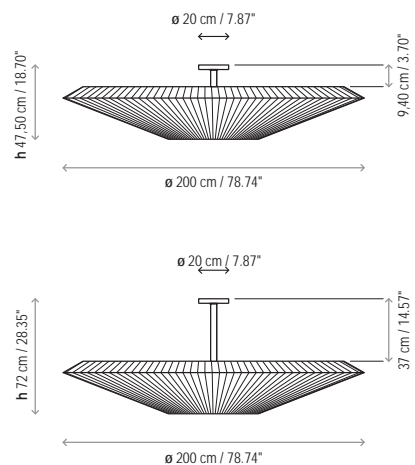

Siam - 80

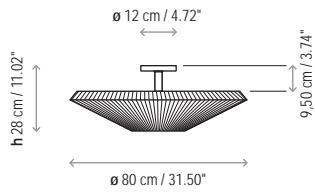

Siam - 120

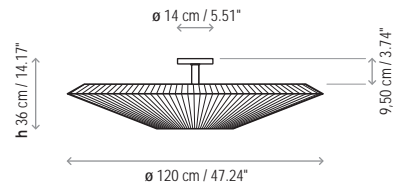

Siam - 150

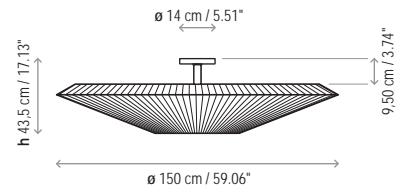

Siam - 200

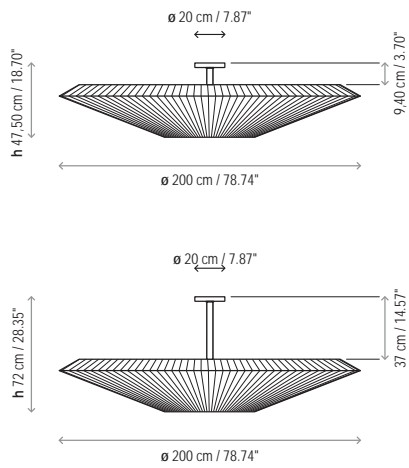

Siam - 4 Luces

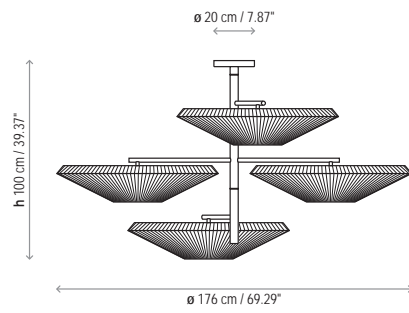

Siam - 6 Luces

