

Name: Urban - 90

Design: Joana Bover / 2011

Typology: Ceiling lamp







Environment: Indoor

Technical description:

Ceiling lamp releasing diffused light through a chrome fixture with hand wrapped translucent polyester blend ribbon. The frosted methacrylate diffuser is included, and clients can choose among white, cream or red ribbon options.



Lamps description

	Grounding: compulsory
	Ready for mounting on normally flammable surface
	4 x 24 W 2G11
Voltage: 230V~50Hz	
	1 Box 95 x 95 x 45 cm
Vol.: 0,4061 m ³	
Weight: 18 kg	
Certifications:  	
	Photometrics made according to the position the lights are shown in the catalogue and price list.

Ref	Finishings
0432506B	Chrome White Translucent Ribbon
0432506C	Chrome Cream Translucent Ribbon
0432506R	Chrome Red Translucent Ribbon
D0432506B	Dali Dimming System Chrome White Translucent Ribbon
D0432506C	Dali Dimming System Chrome Cream Translucent Ribbon
D0432506R	Dali Dimming System Chrome Red Translucent Ribbon

Measures

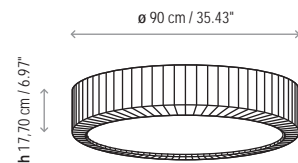

Customizable

Urban - 37

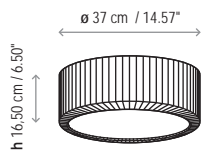

Urban - 60

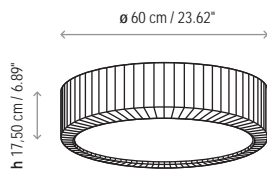

Urban - 90

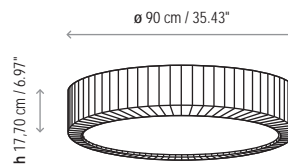

Urban - 120

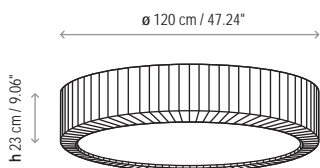

Urban - 37

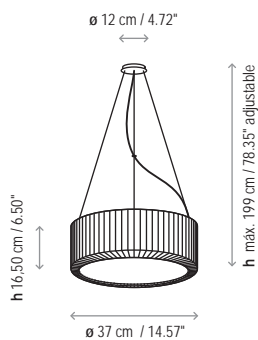

Urban - 60

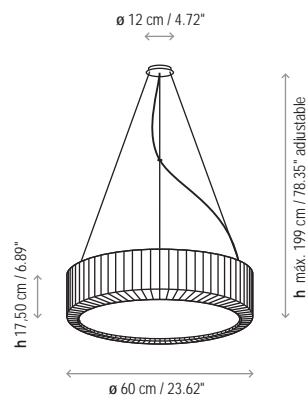

Urban - 90

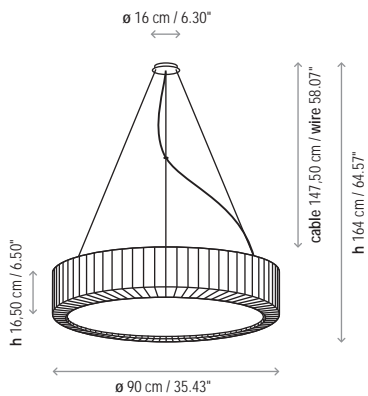

Urban - 120

