

Name: Danona - Pie

Design: Joana Bover / 2002

Typology: Floor lamp

Environment: Indoor

Technical description:

Floor lamp with iron structure available in satin nickel, nickel with dark leather trim and nickel with light leather trim finishing. Lampshade available in cotton and white or cream translucent polyester blend hand wrapped ribbon. Includes a methacrylate diffuser.



Lamps description

 Grounding: excluded

 2 x 46 W Classic P Eco E-27

 2 x 11 W E-27

Voltage: 230V~50Hz

 1 Box 35 x 45 x 165 cm

Vol.: 0,2599 m³

Weight: 7 kg

Certifications:  

 Photometrics made according to the position the lights are shown in the catalogue and price list.

Ref Finishings

3023105 Satin Nickel

3023160 Nickel Dark Leather

3023161 Nickel Caramel Leather

Lampshade 40 X 22 X 40 Cm

P-133 Cotton

P-137 White Translucent Ribbon

P-138 Cream Translucent Ribbon

Lampshade components and methacrylate diffuser included

Customizable

Measures

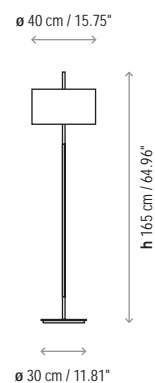

Danona - 1 Luz

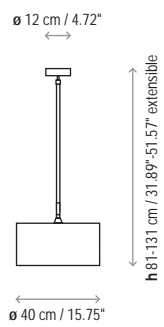

Danona - 3 Luces

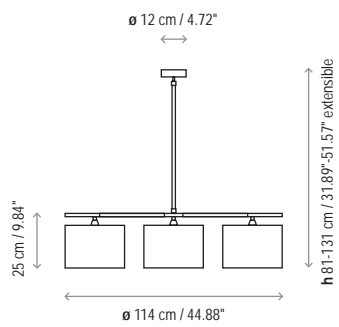

Danona - Mini

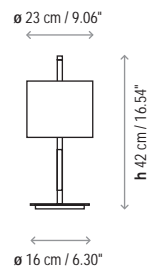

Danona - Mesa

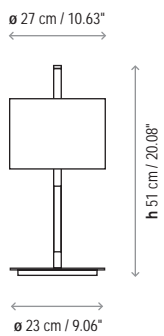

Danona - Pie

