

Name: Danona - 1 Luz

Design: Joana Bover / 2002

Typology: Pendant lamp

Environment: Indoor

Technical description:

Pendant lamp with iron structure available in satin nickel, nickel with dark leather trim and nickel with light leather trim finishing. Lampshade available in cotton and white or cream translucent polyester blend hand wrapped ribbon. Includes a methacrylate upper diffuser.



Lamps description

 Grounding: excluded

 Ready for mounting on normally flammable surface

 1 x 77 W Classic A Eco E-27

 1 x 18 W E-27

Voltage: 230V~50Hz

 1 Box 65 x 65 x 55 cm

Vol.: 0,2324 m³

Weight: 3 kg

Certifications:  

 Photometrics made according to the position the lights are shown in the catalogue and price list.

Ref Finishings

4123105 Satin Nickel

4123160 Nickel Dark Leather

4123161 Nickel Caramel Leather

Lampshade 40 X 22 X 40 cm

P-416 Cotton

P-420 White Translucent Ribbon

P-421 Cream Translucent Ribbon

The shade includes upper diffuser

Customizable all sizes

Measures

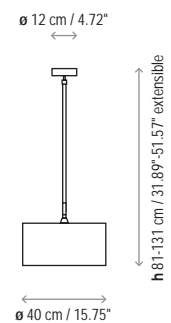

Danona - 1 Luz

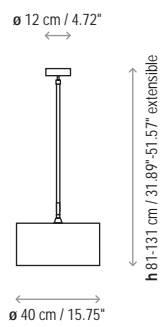

Danona - 3 Luces

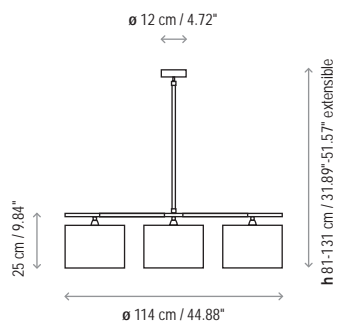

Danona - Mini

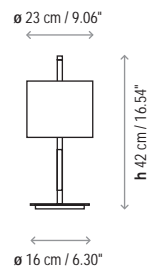

Danona - Mesa

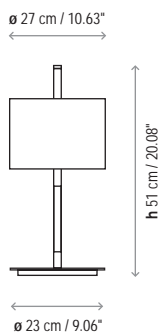

Danona - Pie

