

Name: Carlota - G

Design: Joana Bover / 2003

Typology: Wall lamp

Environment: Indoor

Technical description:

Wall light with brass structure coated in satin nickel, brilliant chrome, nickel with dark leather trim, or nickel with light caramel leather trim finishing.

Square shaped lamp shade is available in cotton and white or cream translucent, hand wrapped polyester blend ribbon. The Carlota features a swivel arm that allows for easy, swift movement.

Available in smaller format.



## Lamps description

 Grounding: excluded

 Ready for mounting on normally flammable surface

 1 x 46 W Classic P Eco E-27

 1 x 11 W E-27

Voltage: 230V~50Hz

 1 Box 45 x 45 x 35 cm

Vol.: 0,0709 m<sup>3</sup>

Weight: 2 kg

Certifications:  

 Photometrics made according to the position the lights are shown in the catalogue and price list.

## Ref Finishings

1524005 Satin Nickel

1524006 Brilliant Chrome

1524060 Nickel Dark Leather

1524061 Nickel Caramel Leather

Square lampshade 23 X 17 X 12 cm

P-487 Cotton

P-486 White Translucent Ribbon

P-489 Cream Translucent Ribbon

Surface back box  $\varnothing$  11 cm

Swivel arm / Brass-raw material

Customizable

## Measures

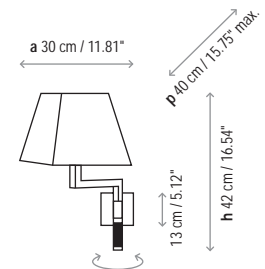

Carlota - A

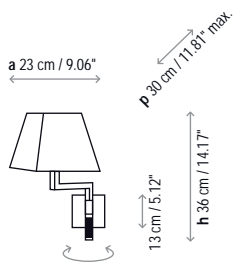

Carlota - G

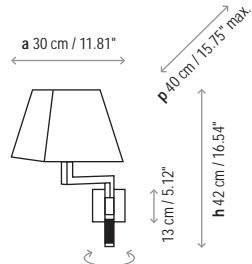

Carlota Doble Articulado

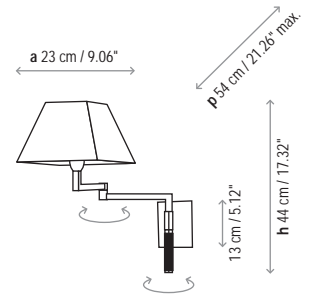

Carlota - G FL

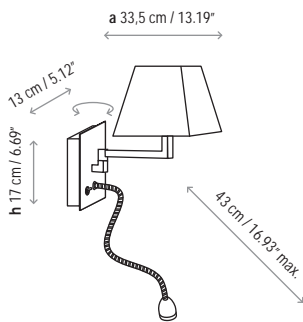

Carlota Doble FL

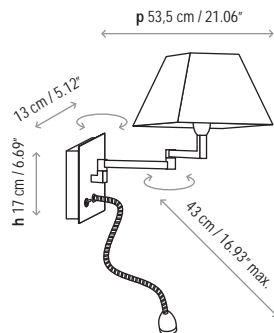

Carlota - T



Carlota - Pie

