

Name: Carlota - A

Design: Joana Bover / 2003

Typology: Wall lamp

Environment: Indoor

Technical description:

Wall lamp with brass structure coated in satin nickel, brilliant chrome, nickel with dark leather trim, or nickel with light caramel leather trim finishing.

Squared shaped lamp shade is available in cotton and white or cream translucent, hand wrapped polyester blend ribbon. The Carlota features a swivel arm that allows for easy, swift movement.

Also available in larger size.



Lamps description

 Grounding: excluded

 1 x 46 W Classic P Eco E-27

Voltage: 230V~50Hz

 1 Box 45 x 45 x 35 cm

Vol.: 0,0709 m³

Weight: 2 kg

Certifications: 

 Photometrics made according to the position the lights are shown in the catalogue and price list.

Ref Finishings

1024005 Satin Nickel

1024006 Brilliant Chrome

1024060 Nickel Dark Leather

1024061 Nickel Caramel Leather

Square lampshade 20 x 15 x 10 cm

P-107 Cotton

P-202 White Translucent Ribbon

P-203 Cream Translucent Ribbon

Surface back box \varnothing 11 cm

Swivel arm / Brass-raw material

Customizable

Measures

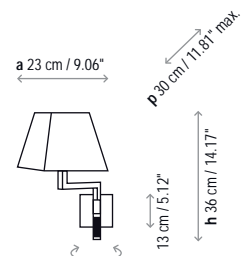

Carlota - A

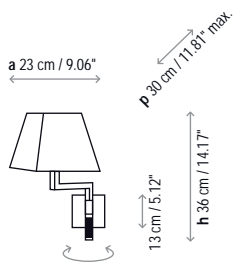

Carlota - G

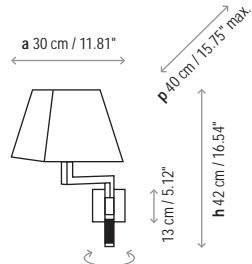

Carlota Doble Articulado

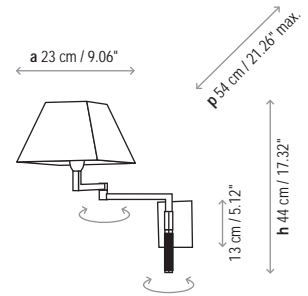

Carlota - G FL

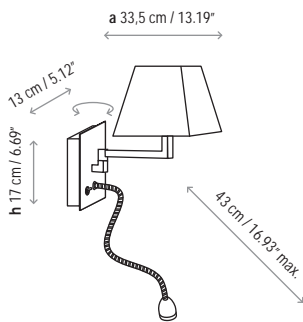

Carlota Doble FL

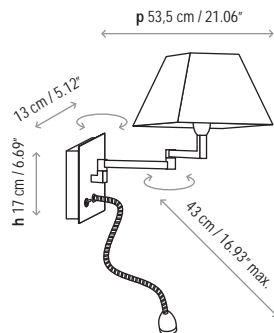

Carlota - T



Carlota - Pie

