



Mundus imaginabilis.

Vmbra
Vmbra
Vmbra
Vmbra
Vmbra
Terra
Aqua
Aeris grossi
Aeris tenuis
Ignis

Mundus sensibilis.

Terra
Aer tenuis
Aer grossus
Ignis
Lux
Sensitivus

Mens.
Intellectus
Ratio
Estimativa
Anima
Hic Anima est
Cognitiva

Mundi elementa & elementatorum imagines capiens.

Mundi elementa & elementatorum prout sunt.

Sensitiva
Anima
Hic Anima est
Cognitiva
Vermis

mind led

LED. Philosophy

Tactus.

Visus
Odoratus
Gustus

Auditus.

Memorativa

Prima medulla



VOLUPTAS SWITCH WALL LAMP

4 LED x 1 W / 700mA / IP 20 / CRI>80 / PSU included



See also p. 40
42

68
70

100



design
Lorenzo Truant

Aluminium wall light painted matt white RAL 9016 and with rubber-coated flexible rod. High Power LED 4 x 1W light source.

Applique en aluminium peint blanc RAL 9016 opaque avec manche flexible recouvert de caoutchouc. Source lumineuse High Power LED 4 x 1W.

Luminaria de parede em alumínio envernizado branco RAL 9016 opaco com haste flexível revestida em borracha. Fonte de luz High Power LED 4 x 1W.

Lampada a parete in alluminio verniciato bianco RAL 9016 opaco con asta flessibile rivestita in gomma. Fonte luminosa High Power LED 4 x 1W.

Wandleuchte aus Aluminium weiß matt RAL 9016 lackiert mit beweglicher Stange mit Gummi verkleidet. Lichtquelle High Power LED 4 x 1W.

Lámpara de pared de aluminio pintado de color blanco RAL 9016 mate, con eje flexible revestido de goma. Fuente de luz High Power LED 4 x 1W.

Настенный светильник из алюминия, окрашенного в матовый белый цвет RAL 9016, с гибким стержнем, покрытым резиной. Источник света: мощные светодиоды 4 x 1 Вт.

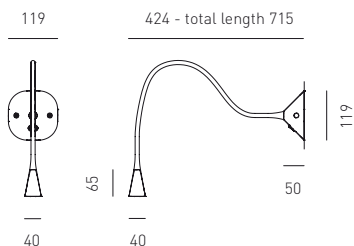

VOLUPTAS SWITCH / 4 LED x 1 W / 700mA / IP 20 / CRI>80 / PSU included

Zone	Type	Article	System compatibility	Finish	LED colour temperature	Beam options
E	1	110	0	07 white 9016 matt	1 3000 K 3 4000 K	4 diffused



example composition code | E | 1 | 110 | 0 | 07 | 1 | 4

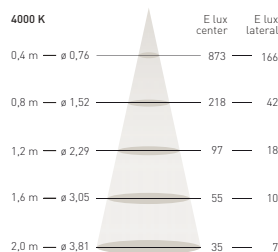
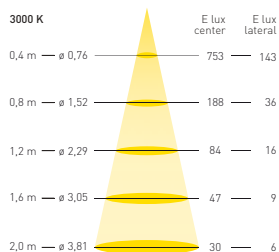
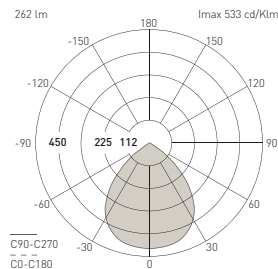
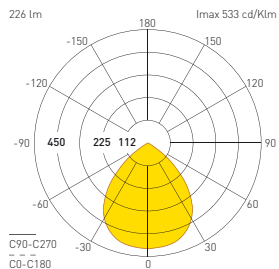



VOLUPTAS ARM WALL LAMP

4 LED x 1 W / 700mA / IP 20 / CRI>80 / PSU not included



See also p. 38
42

68
70

100



design
Lorenzo Truant

Aluminium wall light painted matt white RAL 9016 and with rubber-coated flexible rod. High Power LED 4 x 1W light source.

Applique en aluminium peint blanc RAL 9016 opaque avec manche flexible recouvert de caoutchouc. Source lumineuse High Power LED 4 x 1W.

Luminaria de parede em alumínio envernizado branco RAL 9016 opaco com haste flexível revestida em borracha. Fonte de luz High Power LED 4 x 1W.

Lampada a parete in alluminio verniciato bianco RAL 9016 opaco con asta flessibile rivestita in gomma. Fonte luminosa High Power LED 4 x 1W.

Wandleuchte aus Aluminium weiß matt RAL 9016 lackiert mit beweglicher Stange mit Gummi verkleidet. Lichtquelle High Power LED 4 x 1W.

Lámpara de pared de aluminio pintado de color blanco RAL 9016 mate, con eje flexible revestido de goma. Fuente de luz High Power LED 4 x 1W.

Настенный светильник из алюминия, окрашенного в матовый белый цвет RAL 9016, с гибким стержнем, покрытым резиной. Источник света: мощные светодиоды 4 x 1 Вт.

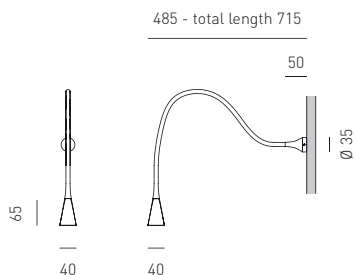

VOLUPTAS ARM / 4 LED x 1 W / 700mA / IP 20 / CRI>80 / PSU not included

Zone	Type	Article	System compatibility	Finish	LED colour temperature	Beam options
E	1	107	0	07 white 9016 matt	1 3000 K 3 4000 K	4 diffused



example composition code | E | 1 | 107 | 0 | 07 | 1 | 4

Collegare in serie. Cavo 1500 mm.
Wire in series. Cable 1500 mm.

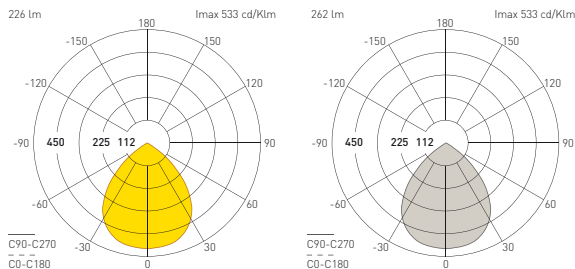

Distance	3000 K		4000 K	
	E lux center	E lux lateral	E lux center	E lux lateral
0,4 m — ø 0,76	753	143	873	166
0,8 m — ø 1,52	188	36	218	42
1,2 m — ø 2,29	84	16	97	18
1,6 m — ø 3,05	47	9	55	10
2,0 m — ø 3,81	30	6	35	7





VOLUPTAS WALL LAMP

4 LED x 1 W / 700mA / IP 20 / CRI>80 / PSU included



See also p. 38
40

68
70

100



design
Lorenzo Truant

Aluminium wall light painted matt white RAL 9016 and with rubber-coated flexible rod. High Power LED 4 x 1W light source.

Applique en aluminium peint blanc RAL 9016 opaque avec manche flexible recouvert de caoutchouc. Source lumineuse High Power LED 4 x 1W.

Luminaria de parede em alumínio envernizado branco RAL 9016 opaco com haste flexível revestida em borracha. Fonte de luz High Power LED 4 x 1W.

Lampada a parete in alluminio verniciato bianco RAL 9016 opaco con asta flessibile rivestita in gomma. Fonte luminosa High Power LED 4 x 1W.

Wandleuchte aus Aluminium weiß matt RAL 9016 lackiert mit beweglicher Stange mit Gummi verkleidet. Lichtquelle High Power LED 4 x 1W.

Lámpara de pared de aluminio pintado de color blanco RAL 9016 mate, con eje flexible revestido de goma. Fuente de luz High Power LED 4 x 1W.

Настенный светильник из алюминия, окрашенного в матовый белый цвет RAL 9016, с гибким стержнем, покрытым резиной. Источник света: мощные светодиоды 4 x 1 Вт.

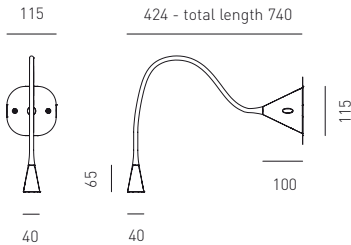

VOLUPTAS / 4 LED x 1 W / 700mA / IP 20 / CRI>80 / PSU included

Zone	Type	Article	System compatibility	Finish	LED colour temperature	Beam options
E	3	107	0	07 white 9016 matt	1 3000 K 3 4000 K	4 diffused



example composition code | E | 3 | 107 | 0 | 07 | 1 | 4

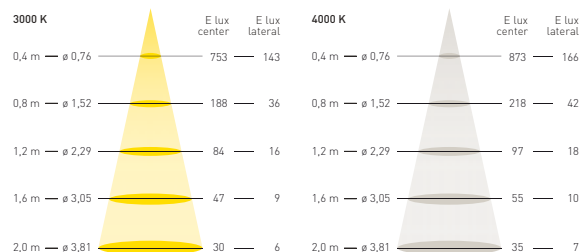
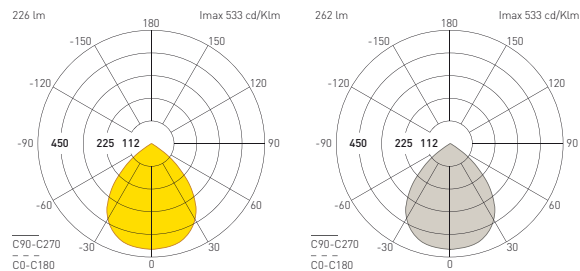





INDOOR
DECO
CEILING

Deus hic in hylam sua ma-
teriam informem ad manda-
creationem se immergit

Spiritus
formis inspi-
tus in homine

Deus Pater

Verbum

Spiritus Sanctus

Mens

Intellectus

Ratio

Voluntas

Saturnus

Jupiter

Mars

Sol

Venus

Mercurius

Luna

Ignis

Aeris reg. Sup

Aeris reg. med

Aeris reg. infi.

Aqua dule

Aqua Salza

Terra

f
c
bl
oc
bb
aa
gg
f
c
d
c
b
a
g
F
E
D
C
B
A
L

Proportio dupla.

Proportio dupla.

Proportio quadrupla.

Proportio dupla.



VOLUPTAS & VOLUPTAS 140 CEILING LAMP

4 LED x 1 W / 700mA / IP 20 / CRI>80 / PSU included



See also p. 38
40
42

70

100



design
Lorenzo Truani

Aluminium ceiling light painted matt white RAL 9016 and with rubber-coated flexible rod. High Power LED 4 x 1W light source.

Plafonnier en aluminium peint blanc RAL 9016 opaque avec manche flexible recouvert de caoutchouc. Source lumineuse High Power LED 4 x 1W.

Lusminaria de teto em alumínio envernizado branco RAL 9016 opaco com haste flexível revestida em borracha. Fonte de luz High Power LED 4 x 1W.

Lampada a soffitto in alluminio verniciato bianco RAL 9016 opaco con asta flessibile rivestita in gomma. Fonte luminosa High Power LED 4 x 1W.

Deckenlampe aus Aluminium weiß matt RAL 9016 lackiert mit beweglicher Stange mit Gummi verkleidet. Lichtquelle High Power LED 4 x 1W.

Lámpara de techo de aluminio pintado de color blanco RAL 9016 mate, con eje flexible revestido de goma. Fuente de luz High Power LED 4 x 1W.

Потолочный светильник из алюминия, окрашенного в матовый белый цвет RAL 9016, с гибким стержнем, покрытым резиной. Источник света: мощные светодиоды 4 x 1 Вт.

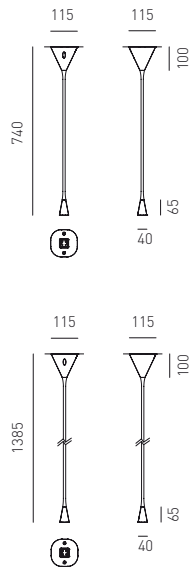

VOLUPTAS / 4 LED x 1 W / 700mA / IP 20 / CRI>80 / PSU included

Zone	Type	Article	System compatibility	Finish	LED colour temperature	Beam options
E	3	107	0	07 white 9016 matt	1 3000 K 3 4000 K	4 diffused

VOLUPTAS 140 / 4 LED x 1 W / 700mA / IP 20 / CRI>80 / PSU included

Zone	Type	Article	System compatibility	Finish	LED colour temperature	Beam options
E	3	108	0	07 white 9016 matt	1 3000 K 3 4000 K	4 diffused



example composition code | E | 3 | 107 | 0 | 07 | 1 | 4

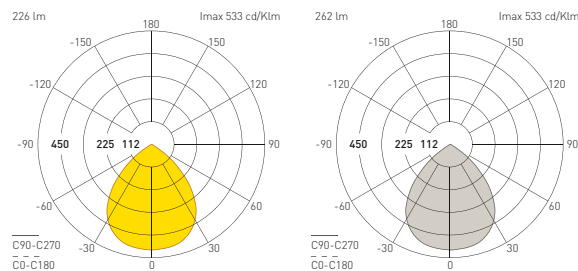

3000 K	E lux center	E lux lateral	4000 K	E lux center	E lux lateral
0,4 m — ø 0,76	753	143	0,4 m — ø 0,76	873	166
0,8 m — ø 1,52	188	36	0,8 m — ø 1,52	218	42
1,2 m — ø 2,29	84	16	1,2 m — ø 2,29	97	18
1,6 m — ø 3,05	47	9	1,6 m — ø 3,05	55	10
2,0 m — ø 3,81	30	6	2,0 m — ø 3,81	35	7





VOLUPTAS 4-140 CEILING LAMP

16 LED x 1 W / 700mA / IP 20 / CRI>80 / PSU included



See also p. 38
40
42

68

100



design
Lorenzo Truanti

Aluminium ceiling light painted matt white RAL 9016 and with rubber-coated flexible rod. High Power LED 16 x 1W light source.

Plafonnier en aluminium peint blanc RAL 9016 opaque avec manche flexible recouvert de caoutchouc. Source lumineuse High Power LED 16 x 1W.

Lusminaria de teto em alumínio envernizado branco RAL 9016 opaco com haste flexível revestida em borracha. Fonte de luz High Power LED 16 x 1W.

Lampada a soffitto in alluminio verniciato bianco RAL 9016 opaco con asta flessibile rivestita in gomma. Fonte luminosa High Power LED 16 x 1W.

Deckenlampe aus Aluminium weiß matt RAL 9016 lackiert mit beweglicher Stange mit Gummi verkleidet. Lichtquelle High Power LED 16 x 1W.

Lámpara de techo de aluminio pintado de color blanco RAL 9016 mate, con eje flexible revestido de goma. Fuente de luz High Power LED 16 x 1W.

Потолочный светильник из алюминия, окрашенного в матовый белый цвет RAL 9016, с гибким стержнем, покрытым резиной. Источник света: мощные светодиоды 16 x 1 Вт.

VOLUPTAS 4 - 140 / 16 LED x 1 W / 700mA / IP 20 / CRI>80 / PSU included

Zone	Type	Article	System compatibility	Finish	LED colour temperature	Beam options
E	3	109	0	07 white 9016 matt	1 3000 K 3 4000 K	4 diffused

CE Intertek LED TEC DRIVER INCLUDED IP20 RoHS

example composition code | E | 3 | 109 | 0 | 07 | 1 | 4

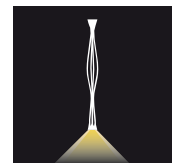
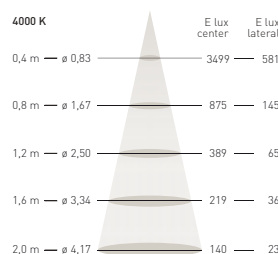
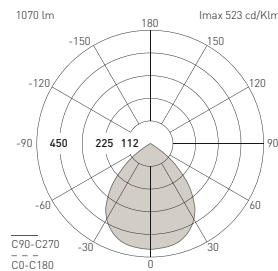
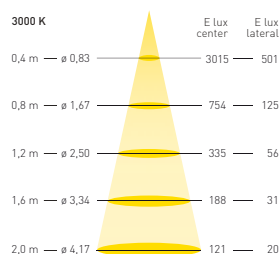
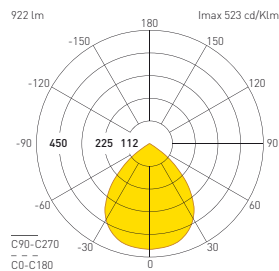
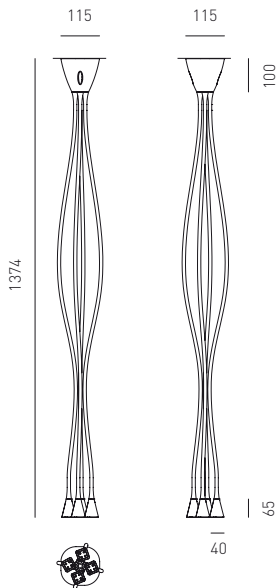



INDOOR DECO TABLE





VOLUPTAS TABLE LAMP

4 LED x 1 W / 700mA / IP 20 / CRI > 80 / PSU included



See also p. 38
40
42

68
70



design
Lorenzo Truant

Aluminium table lamp painted matt white RAL 9016 and with rubber-coated flexible rod. High Power LED 4 x 1W light source.

Lampe de table en aluminium peint blanc RAL 9016 opaque avec manche flexible recouvert de caoutchouc. Source lumineuse High Power LED 4 x 1W.

Luminaria de mesa em alumínio envernizada branca RAL 9016 opaca com haste flexível revestida em borracha. Fonte de luz High Power LED 4 x 1W.

Lampada da tavolo in alluminio verniciato bianco RAL 9016 opaco con asta flessibile rivestita in gomma. Fonte luminosa High Power LED 4 x 1W.

Tischlampe aus Aluminium weiß matt RAL 9016 lackiert mit beweglicher Stange mit Gummi verkleidet. Lichtquelle High Power LED 4 x 1W.

Lámpara de mesa de aluminio pintado de color blanco RAL 9016 mate, con eje flexible revestido de goma. Fuente de luz High Power LED 4 x 1W.

Настольная лампа из алюминия, окрашенного в матовый белый цвет RAL 9016, с гибким стержнем, покрытым резиной. Источник света: мощные светодиоды 4 x 1 Вт.

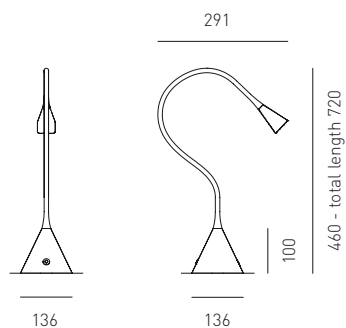

VOLUPTAS / 4 LED x 1 W / 700mA / IP 20 / CRI>80 / PSU included

Zone	Type	Article	System compatibility	Finish	LED colour temperature	Beam options
E	5	107	0	07	1 3000 K 3 4000 K	4 diffused



example composition code | E | 5 | 107 | 0 | 07 | 1 | 4

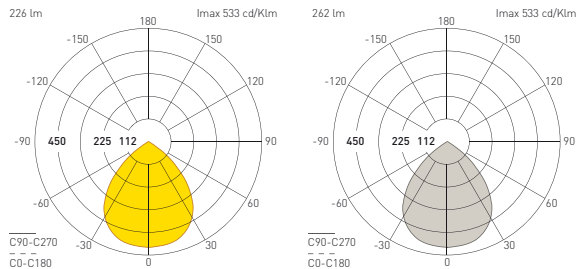

3000 K	E lux center	E lux lateral	4000 K	E lux center	E lux lateral
0,4 m - ø 0,76	753	143	0,4 m - ø 0,76	873	166
0,8 m - ø 1,52	188	36	0,8 m - ø 1,52	218	42
1,2 m - ø 2,29	84	16	1,2 m - ø 2,29	97	18
1,6 m - ø 3,05	47	9	1,6 m - ø 3,05	55	10
2,0 m - ø 3,81	30	6	2,0 m - ø 3,81	35	7





WHEN
ART
MEETS
SPACE
WHEN
MEETS
ART

ACCESSORI / ACCESSORIES

ACCESSORI / ACCESSORIES

ALIMENTATORI / DRIVER

Alimentatori per prodotti Mind-led

Gli alimentatori per L.E.D. Mind-led si caratterizzano per elevata efficienza, peso e volume ridotti e sono dotati di protezioni auto ripristinanti contro le sovra temperature e cortocircuiti.

Le condizioni di garanzia dei prodotti Mind-led si ritengono valide solo ed esclusivamente nel caso di utilizzo

ed installazione corretti degli alimentatori presenti nel seguente catalogo.

In caso di impiego di apparecchiature con caratteristiche diverse da quanto indicato, Axo Light non riterrà valide le condizioni di garanzia generali e verrà esonerata da qualsiasi responsabilità per eventuali danni o malfunzionamenti.

Power supply units for Mind-led products

Mind-led power supply units for L.E.D. are characterised by high efficiency, reduced weight and size and are equipped with automatic reset protection against excess temperatures and short circuits.

The guarantee provisions of Mind-led products are considered valid only and exclusively in cases where the power supply units listed in the following catalogue have been used and installed correctly.

In cases where equipment has been used which has characteristics that differ from those indicated, Axo Light will consider that the general guarantee provisions have been invalidated, and will be absolved from all responsibility for any damage or malfunction.

Netzanschlussgeräte für Mind-Led-Produkte

Netzanschlussgeräte für Mind-LEDs zeichnen sich durch ihre hohe Effizienz, ihr geringes Gewicht und Volumen aus und sind mit einem automatischen Wiedereinschaltenschutz bei Temperaturüberschreitung oder Kurzschluss ausgestattet.

Die Garantiebestimmungen für Mind-Led-Produkte sind ausschließlich bei korrekter Handhabung und Installation der im vorliegenden Katalog angeführten Netzanschlussgeräte gültig. Bei Verwendung von Geräten mit Eigenschaften, die sich von den angeführten unterscheiden, sieht sich Axo light nicht verpflichtet, die Garantiebestimmungen einzuhalten und ist bei möglichen Schäden oder Funktionsfehlern von jedweder Haftung enthoben.

Alimentateurs pour produits Mind-led

Les alimentateurs pour L.E.D. Mind-led se caractérisent par leur efficacité élevée, leur poids et leur volume réduits, et ils sont équipés de protections d'auto-rétablissement contre les températures trop élevées et les courts-circuits.

Les conditions de garantie des produits Mind-led sont valables uniquement et exclusivement en cas d'utilisation et d'installation correctes des alimentateurs figurant sur le catalogue suivant.

En cas d'utilisation d'appareils ayant d'autres caractéristiques que celles indiquées, Axo Light annulera la validité des conditions de garantie générale et sera exonérée de toute responsabilité pour d'éventuels dommages ou mauvais fonctionnements.

Alimentadores para productos Mind-led

Los alimentadores para L.E.D. Mind-led se caracterizan por una elevada eficacia y un peso y un volumen reducidos; disponen de protecciones contra sobretemperaturas y cortocircuitos que se restablecen de forma automática.

Las condiciones de garantía de los productos Mind-led se consideran válidas sólo y exclusivamente si se utilizan y se instalan correctamente los alimentadores presentes en el siguiente catálogo. En caso de empleo de equipos con características distintas de lo que se ha indicado, Axo Light no considerará válidas las condiciones de garantía generales y estará exento de cualquier responsabilidad por eventuales daños o fallos.

Alimentadores para produtos Mind-led

Os alimentadores para L.E.D. Mind-led se caracterizam pela elevada eficiência, peso e volume reduzidos e são dotados de proteções de auto-restauração contra sobretemperaturas e curtos-circuitos.

As condições de garantia dos produtos Mind-led são consideradas válidas somente e exclusivamente no caso de utilização e instalação corretas dos alimentadores presentes no seguinte catálogo.

No caso de uso de aparelhos com características diferentes de quanto indicado, Axo Light não considerará válidas as condições gerais de garantia e será eximida de qualquer responsabilidade para eventuais danos ou maus funcionamentos.

Блоки питания для изделий Mind-led

Блоки питания для светодиодов Mind-led характеризуются высокой эффективностью, малым весом и объемом и оснащены амосстановливающимися устройствами защиты от перегрева и короткого замыкания.

Условия гарантии на продукцию Mind-led действуют только в случае правильного использования и установки блоков питания, присутствующих в следующем каталоге.

В случае использования приборов с характеристиками, отличными от указанных, Axo Light считает общие условия гарантии нарушенными и освобождается от всякой ответственности за возможных ущерб или неисправности.

Collegamento dei LED in serie o in parallelo

Disinserire sempre l'energia elettrica dell'impianto prima di effettuare l'installazione o la manutenzione dei prodotti Mind-led. L'impianto va alimentato solo quando tutti i prodotti ed accessori sono stati opportunamente collegati. Porre massima attenzione alla connessione dei moduli L.E.D. in serie o in parallelo in base alle specifiche del prodotto, rispettando sempre la polarità. Non connettere interruttori sul circuito secondario.

Connection of the LEDs in series or in parallel

Always disconnect the electricity supply from the system before installing or servicing Mind-led products. The system should be switched on only when all products and accessories have been correctly connected. Special attention should be paid to the connection of the LED modules in series or in parallel depending upon the product specifications, always respecting the correct polarities. Do not connect switches to the secondary circuit.

Reihen- oder Parallelschaltung von LEDs

Vor der Installation oder Wartung der Mind-Led-Produkte muss stets die Stromversorgung der Anlage ausgeschaltet werden. Die Anlage wird erst an den Strom angeschlossen, wenn alle Produkte und das Zubehör ordnungsgemäß angeschlossen wurden. Bei Reihen- oder Parallelschluss der LED-Module ist entsprechend der Spezifikationen des Produkts größte Sorgfalt anzuwenden und die Polarität stets einzuhalten. Schalter nicht an den Sekundärstromkreis anschließen.

Branchement des LED en série ou en parallèle

Couper toujours l'électricité de l'équipement avant d'effectuer l'installation ou l'entretien des produits Mind-led. L'équipement sera branché au réseau uniquement lorsque tous les produits et accessoires auront été mis en place. Prêter la plus grande attention à l'installation des modules L.E.D. en série ou en parallèle, selon les spécificités du produit et en respectant toujours les polarités. Ne jamais brancher d'interrupteurs sur le circuit secondaire.

Conexión de los LED en serie o en paralelo

Desconectar siempre la energía eléctrica del equipo antes de efectuar la instalación o el mantenimiento de los productos Mind-led. El equipo se tiene que alimentar sólo cuando todos los productos y accesorios se han conectado de forma oportuna. Prestar la máxima atención a la conexión de los módulos L.E.D. en serie o en paralelo según las especificaciones del producto, respetando siempre las polaridades. No conectar interruptores en el circuito secundario.

Ligação dos LED em série ou em paralelo

Desligar sempre a energia elétrica da instalação antes de realizar a instalação ou a manutenção dos produtos Mind-led. A instalação deve ser alimentada quando todos os produtos e acessórios foram ligados oportunamente. Prestar a máxima atenção na conexão dos módulos L.E.D. em série ou em paralelo segundo as especificações do produto, respeitando sempre as polaridades. Não conectar interruptores no circuito secundário.

Последовательное или параллельное подключение светодиодов

Всегда отключать электропитание системы перед установкой или техническим обслуживанием изделий Mind-led. Питание в систему должно подаваться только после надлежащего подключения всех изделий и аксессуаров. Обращать максимальное внимание на последовательное или параллельное подключение модулей светодиодов в зависимости от спецификаций изделия и с соблюдением полярности. Не подключать выключатель на вторичном контуре.

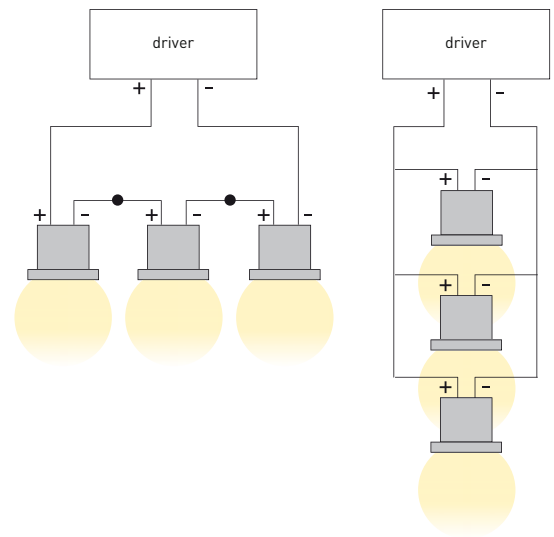

Collegamento in serie dei LED - solo corrente costante.
Connection of the LEDs in series - only constant current.
Reihen - Anschluss von LEDs nur an einer Konstantstromquelle.
branchement en série des LED - uniquement courant constant.
Conexión en serie de los LED - sólo corriente constante.
Ligação em série dos LED - somente corrente constante.
последовательное подключение светодиодов - только постоянный ток.
350/500/700/1000 mA

Collegamento in parallelo dei LED - solo tensione costante.
Connection of the LEDs in parallel - only constant voltage.
Parallel - Anschluss von LEDs nur an einer Konstantspannungsquelle.
Branchement en parallèle des LED - uniquement courant constant.
Conexión en paralelo de los LED - sólo corriente constante.
Ligação dos LED em paralelo - somente tensão constante.
параллельное подключение светодиодов - только постоянное напряжение.
24 V dc

ACCESSORI / ACCESSORIES

ALIMENTATORI / DRIVER

700 mA

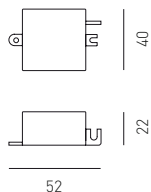

STANDARD

Code	W Max	Led 3 W	Led 6 W	Input	Output	Weight	Certification
CEDLTC00109	6	1-3	1	100-240 V 50-60 Hz	700mA cost. 12 V	35 gr.	CE IP20 RoHS

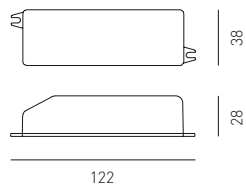

Code	W Max	Led 3 W	Led 6 W	Input	Output	Weight	Certification
CEDLTC00111	17	1-6	1-2	220-240 V 50-60 Hz	700mA cost. 27 V	106 gr.	CE IP20 RoHS

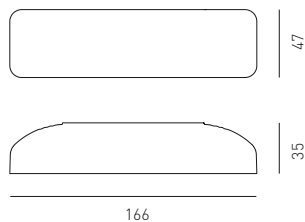

Code	W Max	Led 3 W	Led 6 W	Input	Output	Weight	Certification
CEDLTC00112	32	3-9	1-5	220-240 V 50-60 Hz	700mA cost. 46 Vmax	185 gr.	CE IP20 RoHS

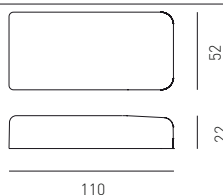

DIMMABLE 1-10V

Code	W Max	Led 3 W	Led 6 W	Input	Output	Weight	Certification
CEDLTC00113	20	1-6	1-3	110-240 V 50-60 Hz	700mA cost. 28 Vmax	80 gr.	CE IP20 RoHS

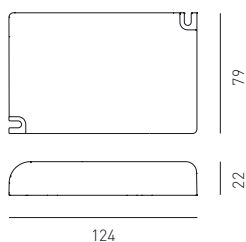

Code	W Max	Led 3 W	Led 6 W	Input	Output	Weight	Certification
CEDLTC00114	50	1-16	1-8	110-240 V 50-60 Hz	700mA cost. 70 Vmax	150 gr.	CE IP20 RoHS

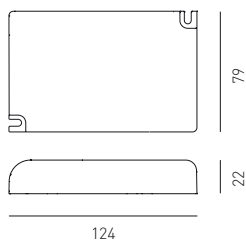

DALI

Code	W Max	Led 3 W	Led 6 W	Input	Output	Weight	Certification
CEDLTC00104	50	1-16	1-8	110-240 V 50-60 Hz	700mA cost. 70 Vmax	150 gr.	CE IP20 RoHS

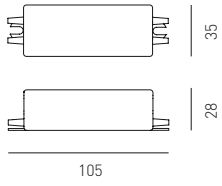

IP 67

Code	W Max	Led 3 W	Led 6 W	Input	Output	Weight	Certification
CEDLLG00307	12	1-4	1-2	120-240 V 50-60 Hz	700mA cost. 2-18 V	181 gr.	CE IP67  RoHS

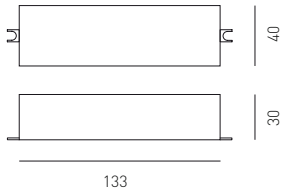

Code	W Max	Led 3 W	Led 6 W	Input	Output	Weight	Certification
CEDLLG00308	36	1-12	1-6	220-240 V 50-60 Hz	700mA cost. 4-52 V	280 gr.	CE IP67  RoHS

LEGEND

LEGENDA LEGENDE LÉGENDE LEYENDA
LEGENDA УСЛОВНЫЕ ОБОЗНАЧЕНИЯ



I nostri prodotti sono tutti sottoposti alle prove di sicurezza elettrica e conformi alle Direttive Comunitarie Europee EN60598-1, LVD 2006/95/EC, EMC 2004/108/EC (ove previsto).

All our products undergo electric safety tests and comply with ECC Directive EN60598-1, LVD 2006/95/EC, EMC 2004/108/EC (where provided).

Entsprechend den Europäischen Normen EN60598-1, LVD 2006/95/EC, EMC 2004/108/EC (sofern vorgesehen), werden alle Produkte den elektrischen Sicherheitsprüfungen unterzogen.

Tous nos produits sont soumis aux tests de sécurité, et sont conformes aux Directives CEE EN60598-1, LVD 2006/95/EC, EMC 2004/108/EC (le cas échéant).

Todos nuestros productos han sido sometidos a las pruebas de seguridad eléctrica y son conformes con las directivas comunitarias europeas EN60598-1, LVD 2006/95/EC, EMC 2004/108/EC (en los casos previstos).

Os nossos produtos são todos submetidos aos testes de segurança elétrica e conformes às Diretivas Comunitárias Europeias EN60598-1, LVD 2006/95/EC, EMC 2004/108/EC (se previsto).

Все наши изделия проходят испытания на электрическую безопасность и соответствуют директивам Европейского Сообщества EN60598-1, LVD 2006/95/EC, EMC 2004/108/EC (в случаях, когда это предусмотрено).



Prodotto conforme alle norme di sicurezza europee certificato Intertek.

Product in conformity with Intertek certificate for European safety standards.

Das Produkt entspricht den europäischen Sicherheitsrichtlinien, Intertek-Zertifizierung.

Produit conforme aux normes de sécurité européennes certifié Intertek.

El producto cumple con las normas de seguridad europeas, certificado Intertek.

Produzido de conformidade com as normas de segurança europeias certificado Intertek

Изделие соответствует европейским стандартам безопасности и имеет сертификат Intertek.



Apparecchio con tecnologia LED
Device with LED technology
Gerät mit LED-Technologie
Dispositif à technologie LED
Aparato con tecnología LED
Aparelho com tecnologia LED
Прибор со светодиодной технологией



Driver incluso nel prodotto
Power supply unit included
Treiber im Produkt inbegriffen
Driver inclus dans le produit
Driver incluido en el producto
Unidade de abastecimento de potência incluída no produto
Блок питания включен в комплект



DIMMER
Predisposto con variatore di luce
With dimmer
Mit Dimmer
Avec dimmer
Con dimmer
Predisposto com variador de luz
Предусмотрено с диммер



Dimmerabile solo con driver dedicato
Dimmable only with dedicated power supply unit
Nur mit dem vorgesehenen Treiber dimmbar
Dimmerable uniquement avec driver spécifique
Regulable sólo con driver específico
Atenuável somente com unidade de abastecimento de potência dedicada
Регулировка яркости возможна только со специальным блоком питания



Prodotto da interni
Indoor product
Produkt für den Innenbereich
Produit d'intérieur
Producto para interiores
Produto para interiores
Изделие для внутренней установки



Prodotto da esterni con grado di protezione IPXY elevato
Outdoor products with high IPXY protection
Produkt für den Außenbereich mit hohem IPXY-Schutzgrad
Produit pour l'extérieur au niveau de protection IPXY élevé
Producto para exteriores grado de protección IPXY elevado
Produto para exteriores com grau de proteção IPXY elevado
Изделие наружной установки с высокой степенью защиты IPXY

IPXY

Grado di protezione contro corpi solidi X – e contro i liquidi Y
Protection rating against solid bodies X – against liquids Y
Schutzgrad X gegen feste Körper – Schutzgrad Y gegen Flüssigkeiten
Niveau de protection contre corps solides X – et contre les liquides Y
Grado de protección contra cuerpos sólidos X – y contra los líquidos Y
Grau de proteção contra corpos sólidos X – e contra os líquidos Y
Степень защиты от проникновения твердых тел X и жидкостей Y



Peso lordo in Kg del prodotto
Gross Kg weight of the product
Bruttogewicht des Produkts in kg
Poids brut en Kg du produit
Peso bruto en Kg del producto
Peso bruto do produto em Kg
Полная масса изделия в кг



Apparecchio calpestabile
Walk over device
Gerät ist begehbar
Appareil piétinable
Aparato pisable a pie
Aparelho que pode ser pisado
Прибор, пригодный для хождения



Apparecchio carrabile a kg...
Device can withstand weights up to kg...
Gerät kann mit ... kg befahren werden
Appareil carrossable à kg ...
Aparato transitabile hasta ... kg
Aparelho carroçável com kg...
Прибор может выдерживать вес до ... кг



Luce ruotabile
Rotable light
Licht drehbar
Lumière pivotante
Luz giratoria
Luz rotativa
Поворачиваемый свет



Dimensioni foro per l'incasso
Recessed hole dimension
Maße des Einbauausschnitts
Dimensions trous pour l'encastrement
Tamaño orificio para el empotrado
Medidas furo para o encaixe
Размер отверстия для встраивания



CLASSE 1
Solo isolamento fondamentale; le parti conduttrici accessibili sono collegate ad un conduttore di terra. Messa a terra obbligatoria.
Basic insulation, accessible conductors are earthed. Earthing is compulsory.
Grundisolation: berührbare Metallteile mit Anschlussstelle für Schutzleiter verbunden. Netzschutzleiter: vorgeschrieben.
Isolation de base: les parties conductrices accessibles sont mises à terre. Mise à terre obligatoire.
Solo aislamiento fundamental; las partes conductoras accesibles están conectadas a un conductor de tierra. Puesta a tierra obligatoria.
Somente isolamento fundamental; as partes condutoras acessíveis são conectadas em um condutor de terra. Aterramento obrigatório.
"Изоляция только базовая. Доступные проводниковые части подсоединены к заземлителю. Заземление обязательно.



CLASSE 2
Sistema a doppio isolamento; messa a terra esclusa.
Double insulation. Earthing: excluded.
Doppelte Isolierung. Netzschutzleiter: nicht erlaubt.
Double isolation. Mise à terre: exclue.
Sistema de doble aislamiento; puesta a tierra no incluida.
Sistema com isolamento duplo; aterramento excluído.
Система двойной изоляции. Заземление исключено.



CLASSE 3

Apparecchio in cui la protezione contro la scossa elettrica si basa sulla alimentazione a bassissima tensione di sicurezza.

Appliance in which protection against electrical shock is guaranteed by the extremely low-voltage power supply.

Zum Schutz vor elektrischen Schlägen mit Niedervolt gespeistes Gerät.

Appareil avec protection contre les décharges électriques basée sur l'alimentation à une tension de sécurité très basse.

Aparato en el cual la protección contra la descarga eléctrica se debe a la alimentación a muy baja tensión.

Aparelho no qual a proteção contra choque elétrico baseia-se na alimentação com baixíssima tensão de segurança.

Прибор, в котором защита от удара током основана на питании от очень низкого напряжения.

RoHS

Apparecchio conforme alla normativa RoHS 2002/95/CE (Restriction of Hazardous Substances Directive)

Device conforms to the RoHS 2002/95/CE (Restriction of Hazardous Substances Directive)

Das Gerät entspricht der Norm RoHS 2002/95/CE (Restriction of Hazardous Substances Directive)

Appareil conforme à la réglementation RoHS 2002/95/CE (Restriction of Hazardous Substances Directive)

El aparato cumple con la normativa RoHS 2002/95/CE (Restriction of Hazardous Substances Directive)

Aparelho conforme à norma RoHS 2002/95/CE (Restriction of Hazardous Substances Directive)

Прибор соответствует требованиям RoHS 2002/95/EC (Директива об ограничении опасных веществ)

ADA

Prodotto conforme alla normativa USA A.D.A. (protruding objects).

Product conforms to the USA A.D.A. standards (protruding objects).

Das Produkt entspricht der US-Norm USA A.D.A. (protruding objects)

Produit conforme à la norme USA A.D.A. (protruding objects).



Producto conforme con la normativa USA A.D.A. (protruding objects).





Produto conforme à norma USA A.D.A. (protruding objects).

Изделие соответствует требованиям стандарта США A.D.A. (выступающие объекты).

LEGEND

LEGENDA LEGENDE LÉGENDE LEYENDA
 LEGENDA УСЛОВНЫЕ ОБОЗНАЧЕНИЯ

			
Tipologia	1 Lampada LED a parete	2 Sospensione a LED	3 Lampada LED a soffitto
Type	LED wall light	LED suspended light	LED ceiling luminaire
Typ	LED-Wandleuchte	LED-Hängeleuchte	LED-Deckenleuchte
Typologie	Applique LED	Suspension LED	Plafonnier LED
Tipología	Lámpara LED de pared	Suspensión de LED	Lámpara LED de techo
Tipo	Luminária LED de parede	Pendente com LED	Luminária LED de teto
ТИП	настенный светодиодный светильник	подвесной светодиодный светильник	потолочный светодиодный светильник

				
Variante	0 Versione standard	1 Variante singola	2 Variante decentrata 1 luce	4 Variante ad incasso
System compatibility description	Standard version	Monopoint canopy version	Decentralized version 1 light	Recessed version
Variantenbeschreibung	Standardvariante	Einzelvariante	Dezentrierte Variante mit 1 Lichtquelle	Einbauvariante
Variante description	Version standard	Variante individuelle	Variante décentrée 1 lumière	Variante encastrable
Variante descripción	Variante estándar	Variante individual	Variante descentrada 1 luz	Variante empotrable
Versão descrição	Versão padrão	Versão simples	Versão descentralizada 1 luz	Versão de encaixe
описание варианта	стандартная версия	одинарный вариант	смещенный вариант с 1 лампой	встраиваемый вариант

					
Finitura	00 Finitura non dichiarata	01 finitura cromo	02 finitura argento anodizzato	03 finitura acciaio INOX AISI316 satinato	04 finitura verniciato nero opaco
Finish	Finishing not declared	chrome finish	silver anodized finish	AISI316 satin finish	painted black matt finish
Ausführung	Farbe nicht definiert	Verchromte Ausführung	Ausführung mit eloxiertem Silber	Ausführung in satiniertem INOX AISI316-Stahl	Mattschwarz lackierte Ausführung
Finition	Finition non déclarée	finition chrome	finition argent anodisé	finition acier INOX AISI316 satiné	finition verni noir opaque
Acabado	Acabado no declarado	acabado cromo	acabado plata anodizado	acabado acero inoxidable AISI316 satinado	acabado pintado negro mate
Acabamento	Acabamento não declarada	acabamento cromo	acabamento prata anodizada	acabamento aço INOX AISI316 acetinado	acabamento pintado preto fosco
Отделка	оотделка не сообщена	отделка хром	отделка анодированное серебро	отделка сатинированная сталь INOX AISI316	отделка окраской черной матовой краской



5
Lampada da tavolo LED
LED table lamp
LED-Tischleuchte
Lampe de table LED
Lámpara LED de mesa
Luminária de mesa LED
настольный светодиодный светильник



6
Proiettore LED
LED spotlight
LED-Projektor
Projecteur LED
Projector LED
Spot LED
светодиодный прожектор



7
Incasso tecnico LED
LED recessed downlight
LED-Leuchte mit technischen Einbau
Encastrement technique LED
LED empotrable técnico
Encaixe técnico LED
технический встраиваемый светодиодный светильник



8
Incasso decorativo LED
LED recessed luminaire
LED-Leuchte mit dekorativem Einbau
Encastrement décoratif LED
LED empotrable decorativo
Encaixo decorativo LED
декоративный встраиваемый светодиодный светильник



9
Incasso calpestabile LED
LED in-ground luminaire
LED-Leuchte mit begehbarem Einbau
Encastrement piétinable LED
LED empotrable transitable a pie
Encaixe de chão LED
встраиваемый светодиодный светильник, пригодный для хождения



6*
Variante per binario 220 V
220 V track version
Variante für Schienen
Variante pour rail 220 V
Variante para vía 220 V
Versão para trilho 220 V
вариант для установки на рельс 220 В



7
Variante per rosone multiplo
Multipoint canopy version
Variante für Mehrfachrosetten
Variante pour rosace multiple
Variante para rosetón múltiple
Versão para rosácea múltipla
вариант для розетки на несколько светильников



8
Variante monoemissione
Monoemittig version
Einzelstrahlvariante
Variante mono-émission
Variante monoemisión
Versão mono-emissão
однонаправленный вариант



9
Variante biemissione
Biemittig version
Doppelstrahlvariante
Variante bi-émission
Variante biemisión
Versão bi-emissão
двунаправленный вариант

L'adattatore GA69 è compatibile con i binari:
The GA69 adapter is compatible with tracks from:
Der Adapter GA69 ist kompatibel mit den Schienensystemen:
L'adaptateur GA69 est compatible avec les rails:
El adaptador GA69 es compatible con las guías:
O adaptador GA69 é compatível com os binários:
Адаптер GA69 совместим с шинопроводами:
Global Trac, Erco, I-Guzzini, Eutrac, Hoffmeister, Nuco and Concord Lytespan 3.



05
finitura verniciato grigio RAL 9007 raggrinzato
painted grey RAL 9007 wrinkled finish
RAL-9007 grau lackierte gefälte Ausführung
finition verni gris RAL 9007 plissé
acabado pintado gris RAL 9007 rugoso
acabamento pintado cinza RAL 9007 enrugado
отделка фактурная окраской серой краской RAL 9007



06
finitura verniciato bianco RAL 9016 raggrinzato
painted white RAL 9016 wrinkled finish
RAL-9016 weiß lackierte gefälte Ausführung
finition verni blanc RAL 9016 plissé
acabado pintado blanco RAL 9016 rugoso
acabamento pintado branco RAL 9016 enrugado
отделка фактурная окраской белой краской RAL 9016



07
finitura verniciato bianco RAL 9016 opaco
painted white RAL 9016 matt finish
RAL-9016 mattweiß lackierte gefälte Ausführung
finition verni blanc RAL 9016 opaque
acabado pintado blanco RAL 9016 mate
acabamento pintado branco RAL 9016 fosco
отделка фактурная окраской белой краской RAL 9016





08
nero opaco
matt black
mattschwarz
noir opaque
negro mate
preto fosco
черная матовая



09
bianco opaco
matt white
mattweiß
blanc opaque
blanco mate
branco fosco
белая матовая

LEGEND

LEGENDA LEGENDE LÉGENDE LEYENDA
 LEGENDA УСЛОВНЫЕ ОБОЗНАЧЕНИЯ

	0	 3000K	 4000K
Temperatura Colore LED	senza led	1 luce calda	3 luce naturale
LED Colour Temperature	no led	warm light temperature	natural light temperature
Temperatur Farbiges LEDs	ohne Led	warmes Licht	natürliches Licht
Température Couleur LED	sans led	lumière chaude	lumière naturelle
Temperatura Color LED	sin led	luz cálida	luz natural
Temperatura Cor LED	sem led	luz quente	luz natural
Температура Света Светодиодов	без светодиодов	теплый свет	естественный свет

	0	 10°	 25°	 60°	
Fascio Luminoso	senza lente	1 Fascio stretto	2 fascio medio	3 fascio largo	4 fascio diffuso
Beam Options	no lens	narrow beam	medium beam	large beam	diffused beam
Lichtstrahl	ohne Linse	schmaler Strahl	mittlerer Strahl	breiter Strahl	diffuser Strahl
Faisceau Lumineux	sans verre	faisceau étroit	faisceau moyen	faisceau large	faisceau diffus
Haz Luminoso	sin lente	haz estrecho	haz medio	haz ancho	haz difuso
Feixe Luminoso	sem lente	feixe estreito	feixe médio	feixe largo	feixe difuso
Полоса Света	без линзы	узкая полоса	средняя полоса	широкая полоса	рассеянная полоса



5000K

5

luce fredda

cool light temperature

kaltes Licht

lumière froide

luz fría

luz fria

холодный свет



5

fascio regolabile

adjustable beam

einstellbarer Strahl

faisceau réglable

haz regulable

feixe regulável

регулируемая полоса



6

fascio combinato
largo+stretto

large+narrow
combined beam

kombinierter Strahl
breit+schmal

faisceau combiné large+étroit

haz combinado
ancho+estrecho

feixe combinado
largo+estrito

комбинированная
широкая+узкая полоса

Axo Light si riserva il diritto di apportare ai modelli, senza alcun preavviso, qualsiasi modifica ritenesse opportuna. Axo Light non risponde per eventuali danni a persone o cose causati da una non corretta installazione dei propri apparecchi d'illuminazione. I dati riportati sono puramente indicativi; è possibile che siano riportati degli errori di stampa.

Axo Light reserves itself the right to introduce any changes to its own models, without prior notice. Axo Light is not liable for injuries or damage due to the incorrect installation of its fixtures. The details given here are intended purely as guidance as errors may have occurred during the printing process.

Axo Light behält sich das Recht vor, jederzeit und ohne Voranmeldung, Änderungen der Kollektion vorzunehmen, ohne jedoch die charakteristischen Eigenschaften der Artikel zu ändern. Axo Light ist nicht verantwortlich für eventuelle Personen- oder Sachschäden, verursacht durch unsachgemäße Installation der Produkte. Aufgrund möglicher Druckfehler, sind die angegebenen Daten lediglich als Richtwerte zu verstehen.

Axo Light se réserve le droit de modifier ses collections à tous moments et sans préavis, dans le respect des caractéristiques de base du produit. Axo Light ne répond pas aux éventuels dommages à personnes ou choses causés par une mauvaise installation de ses appareils d'éclairage. Les coordonnées mentionnées sont purement indicatives; il est possible que des erreurs d'impression y figurent.

Axo Light se reserva el derecho de aportar a los propios modelos, sin ningún preaviso, cualquier modificación que se considere oportuna. Axo Light no responde por los eventuales daños causados a personas o cosas provocados por una incorrecta instalación de los propios aparatos de iluminación. Los datos que aparecen son puramente indicativos; es posible que contengan errores de impresión.

Axo Light reserva-se o direito de efetuar nos modelos, sem nenhum pré-aviso, qualquer modificação que considerar oportuna. Axo Light não responde por eventuais danos a pessoas ou coisas causados por uma instalação incorreta dos próprios aparelhos de iluminação. Os dados reproduzidos são meramente indicativos; é possível que estejam indicados erros de impressão.

Axo Light оставляет за собой право вносить модификации моделей без предупреждения, в случае необходимости. Axo Light не несёт ответственности за ущерб людям или вещам, вызванный некорректной установкой осветительных приборов. Приведенные данные носят иллюстративный характер; возможны опечатки.

Misure dei disegni in mm

Measures of the drawings in mm

Maße der Zeichnungen in mm

Dimensions des dessins en mm

Tamaño de los dibujos en mm

Medidas dos desenhos em mm

размеры на рисунках в мм

Le schede tecniche dei prodotti Axo Light sono scaricabili direttamente dal nostro sito:

www.axolight.it

Axo Light technical sheets can be downloaded directly from our website:

www.axolight.it

Die Axo Light Produktdatenblätter können direkt von unserer Website heruntergeladen werden:

www.axolight.it

Les fiches techniques des produits Axo Light peuvent être téléchargés directement de notre site:

www.axolight.it

Las fichas técnicas de los productos Axo Light se pueden descargar directamente de nuestro sitio web:

www.axolight.it

As fichas técnicas dos produtos Axo Light podem ser baixadas diretamente do nosso site:

www.axolight.it

Технические характеристики изделий фирмы Axo Light возможно скачать с нашего сайта:

www.axolight.it