

Mundus imaginabilis.

Vmbra  
Terra  
Vmbra Aquæ  
Vmbra Aeris grossi  
Vmbra Aeris tenuis.  
Vmbra Ignis.

Mundus sensibilis.

Terra

# mind led

LED. Philosophy

Mens.

Intellectus.

Ratio

Hic Anima est

Estimativa

Cogitativa.

Mundi elementa & elementata Sentientia prout sunt.

Sensitiva.

Mundi elementa tota & elementatorum imagines capiens.

Visus

Odoratus

Gustus.

Tactus.

Auditus.

Memorativa.



Primi medulla



INDOOR  
TECH  
**RECESSED**  
**DOWNLIGHT**



*Pyramis radiosa*

*Pyramis radiosa*



# POLITIANUS RECESSED DOWNLIGHT

1 LED x 3 W / 700mA / IP 40 / CRI>80 / PSU not included



Aluminium recessed downlight available in anodized silver or painted matt white RAL 9016 versions. High Power LED 1 x 3W light source. Narrow or medium or wide beam options.

Appareil encastrable en aluminium anodisé ou peint blanc RAL 9016 opaque avec source lumineuse High Power LED 1 x 3W. Disponible avec faisceau lumineux fin ou moyen ou large.

Aparelho de encaixe em alumínio anodizado ou então envernizado branco RAL 9016 opaco com fonte de luz High Power LED 1 x 3W. Disponível com fecho de luz estreito, médio ou largo.

Apparecchio ad incasso in alluminio anodizzato oppure verniciato bianco RAL 9016 opaco con fonte luminosa High Power LED 1 x 3W. Disponibile con fascio luminoso stretto o medio o largo.

Einbaugerät aus Aluminium eloxiert oder weiß matt RAL 9016 lackiert mit Lichtquelle High Power LED 1 x 3W. Erhältlich mit schmalem, mittlerem oder breitem Lichtbündel.

Aparato empotrable de aluminio anodizado o bien pintado de color blanco RAL 9016 mate, con fuente de luz High Power LED 1 x 3W. Disponible con haz de luz estrecho o mediano o ancho.

Встраиваемый прибор из анодированного или окрашенного в матовый белый цвет RAL 9016 алюминия с источником света в виде мощного светодиода 1 x 3 Вт. Предложен с узкой, средней или широкой полосой света.

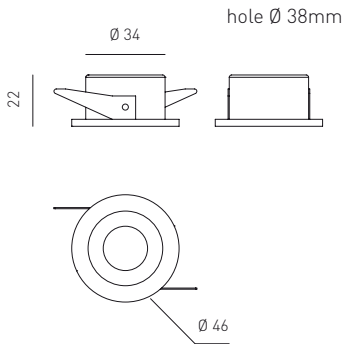

POLITIANUS / 1 LED x 3 W / 700mA / IP 40 / CRI>80 / PSU not included

Zone	Type	Article	System compatibility	Finish	LED colour temperature	Beam options
E	7	502	0	02 silver anodized	1 3000 K	1 10°
				07 white 9016 matt	3 4000 K	2 25°
						3 40°

Collegare in serie. Cavo 350 mm.  
Wire in series. Cable 350 mm.

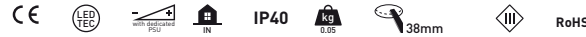

example composition code | E | 7 | 502 | 0 | 02 | 1 | 1

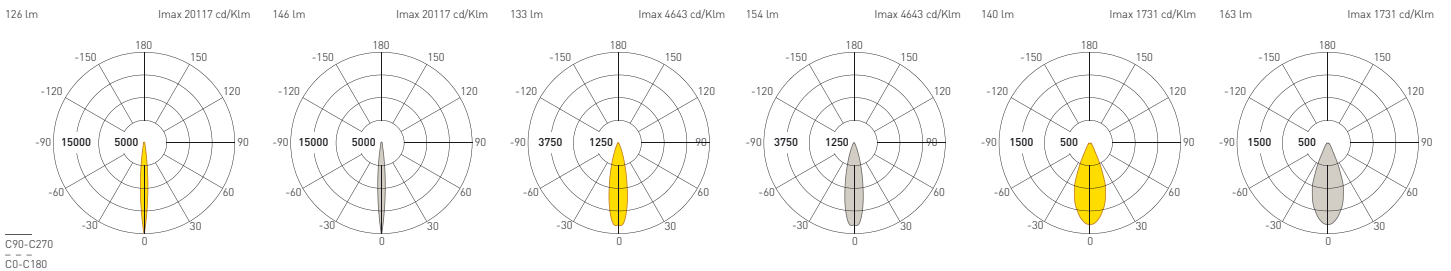

3000 K / 10°	4000 K / 10°	3000 K / 25°	4000 K / 25°	3000 K / 40°	3000 K / 40°
0,5 m — ø 0,08 — E lux center 10139 — E lux lateral 5118	0,5 m — ø 0,08 — E lux center 11748 — E lux lateral 5931	0,5 m — ø 0,21 — E lux center 2451 — E lux lateral 1164	0,5 m — ø 0,21 — E lux center 2839 — E lux lateral 1348	0,5 m — ø 0,38 — E lux center 970 — E lux lateral 398	0,5 m — ø 0,38 — E lux center 1122 — E lux lateral 460
1,0 m — ø 0,15 — E lux center 2535 — E lux lateral 1280	1,0 m — ø 0,15 — E lux center 2937 — E lux lateral 1483	1,0 m — ø 0,42 — E lux center 613 — E lux lateral 291	1,0 m — ø 0,42 — E lux center 710 — E lux lateral 337	1,0 m — ø 0,76 — E lux center 242 — E lux lateral 99	1,0 m — ø 0,76 — E lux center 281 — E lux lateral 115
1,5 m — ø 0,23 — E lux center 1127 — E lux lateral 569	1,5 m — ø 0,23 — E lux center 1305 — E lux lateral 659	1,5 m — ø 0,63 — E lux center 272 — E lux lateral 129	1,5 m — ø 0,63 — E lux center 315 — E lux lateral 150	1,5 m — ø 1,13 — E lux center 108 — E lux lateral 44	1,5 m — ø 1,13 — E lux center 125 — E lux lateral 51
2,0 m — ø 0,30 — E lux center 634 — E lux lateral 320	2,0 m — ø 0,30 — E lux center 734 — E lux lateral 371	2,0 m — ø 0,84 — E lux center 153 — E lux lateral 73	2,0 m — ø 0,84 — E lux center 177 — E lux lateral 84	2,0 m — ø 1,51 — E lux center 61 — E lux lateral 25	2,0 m — ø 1,51 — E lux center 70 — E lux lateral 29
2,5 m — ø 0,38 — E lux center 406 — E lux lateral 205	2,5 m — ø 0,38 — E lux center 470 — E lux lateral 237	2,5 m — ø 1,04 — E lux center 98 — E lux lateral 47	2,5 m — ø 1,04 — E lux center 114 — E lux lateral 54	2,5 m — ø 1,89 — E lux center 39 — E lux lateral 16	2,5 m — ø 1,89 — E lux center 45 — E lux lateral 18
3,0 m — ø 0,45 — E lux center 282 — E lux lateral 142	3,0 m — ø 0,45 — E lux center 326 — E lux lateral 165	3,0 m — ø 1,25 — E lux center 68 — E lux lateral 32	3,0 m — ø 1,25 — E lux center 79 — E lux lateral 37	3,0 m — ø 2,27 — E lux center 27 — E lux lateral 11	3,0 m — ø 2,27 — E lux center 31 — E lux lateral 13



# ACCESSORI / ACCESSORIES



# ACCESSORI / ACCESSORIES

## ALIMENTATORI / DRIVER

### Alimentatori per prodotti Mind-led

Gli alimentatori per L.E.D. Mind-led si caratterizzano per elevata efficienza, peso e volume ridotti e sono dotati di protezioni auto ripristinanti contro le sovra temperature e cortocircuiti.

Le condizioni di garanzia dei prodotti Mind-led si ritengono valide solo ed esclusivamente nel caso di utilizzo

ed installazione corretti degli alimentatori presenti nel seguente catalogo.

In caso di impiego di apparecchiature con caratteristiche diverse da quanto indicato, Axo Light non riterrà valide le condizioni di garanzia generali e verrà esonerata da qualsiasi responsabilità per eventuali danni o malfunzionamenti.

### Power supply units for Mind-led products

Mind-led power supply units for L.E.D. are characterised by high efficiency, reduced weight and size and are equipped with automatic reset protection against excess temperatures and short circuits.

The guarantee provisions of Mind-led products are considered valid only and exclusively in cases where the power supply units listed in the following catalogue have been used and installed correctly.

In cases where equipment has been used which has characteristics that differ from those indicated, Axo Light will consider that the general guarantee provisions have been invalidated, and will be absolved from all responsibility for any damage or malfunction.

### Netzanschlussgeräte für Mind-Led-Produkte

Netzanschlussgeräte für Mind-LEDs zeichnen sich durch ihre hohe Effizienz, ihr geringes Gewicht und Volumen aus und sind mit einem automatischen Wiedereinschaltenschutz bei Temperaturüberschreitung oder Kurzschluss ausgestattet.

Die Garantiebestimmungen für Mind-Led-Produkte sind ausschließlich bei korrekter Handhabung und Installation der im vorliegenden Katalog angeführten Netzanschlussgeräte gültig. Bei Verwendung von Geräten mit Eigenschaften, die sich von den angeführten unterscheiden, sieht sich Axo light nicht verpflichtet, die Garantiebestimmungen einzuhalten und ist bei möglichen Schäden oder Funktionsfehlern von jedweder Haftung enthoben.

### Alimentateurs pour produits Mind-led

Les alimentateurs pour L.E.D. Mind-led se caractérisent par leur efficacité élevée, leur poids et leur volume réduits, et ils sont équipés de protections d'auto-rétablissement contre les températures trop élevées et les courts-circuits.

Les conditions de garantie des produits Mind-led sont valables uniquement et exclusivement en cas d'utilisation et d'installation correctes des alimentateurs figurant sur le catalogue suivant.

En cas d'utilisation d'appareils ayant d'autres caractéristiques que celles indiquées, Axo Light annulera la validité des conditions de garantie générale et sera exonérée de toute responsabilité pour d'éventuels dommages ou mauvais fonctionnements.

### Alimentadores para productos Mind-led

Los alimentadores para L.E.D. Mind-led se caracterizan por una elevada eficacia y un peso y un volumen reducidos; disponen de protecciones contra sobretemperaturas y cortocircuitos que se restablecen de forma automática.

Las condiciones de garantía de los productos Mind-led se consideran válidas sólo y exclusivamente si se utilizan y se instalan correctamente los alimentadores presentes en el siguiente catálogo. En caso de empleo de equipos con características distintas de lo que se ha indicado, Axo Light no considerará válidas las condiciones de garantía generales y estará exento de cualquier responsabilidad por eventuales daños o fallos.

### Alimentadores para produtos Mind-led

Os alimentadores para L.E.D. Mind-led se caracterizam pela elevada eficiência, peso e volume reduzidos e são dotados de proteções de auto-restauração contra sobretemperaturas e curtos-circuitos.

As condições de garantia dos produtos Mind-led são consideradas válidas somente e exclusivamente no caso de utilização e instalação corretas dos alimentadores presentes no seguinte catálogo.

No caso de uso de aparelhos com características diferentes de quanto indicado, Axo Light não considerará válidas as condições gerais de garantia e será eximida de qualquer responsabilidade para eventuais danos ou maus funcionamentos.

### Блоки питания для изделий Mind-led

Блоки питания для светодиодов Mind-led характеризуются высокой эффективностью, малым весом и объемом и оснащены амосстановливающимися устройствами защиты от перегрева и короткого замыкания.

Условия гарантии на продукцию Mind-led действуют только в случае правильного использования и установки блоков питания, присутствующих в следующем каталоге.

В случае использования приборов с характеристиками, отличными от указанных, Axo Light считает общие условия гарантии нарушенными и освобождается от всякой ответственности за возможных ущерб или неисправности.



### Collegamento dei LED in serie o in parallelo

Disinserire sempre l'energia elettrica dell'impianto prima di effettuare l'installazione o la manutenzione dei prodotti Mind-led. L'impianto va alimentato solo quando tutti i prodotti ed accessori sono stati opportunamente collegati. Porre massima attenzione alla connessione dei moduli L.E.D. in serie o in parallelo in base alle specifiche del prodotto, rispettando sempre la polarità. Non connettere interruttori sul circuito secondario.

### Connection of the LEDs in series or in parallel

Always disconnect the electricity supply from the system before installing or servicing Mind-led products. The system should be switched on only when all products and accessories have been correctly connected. Special attention should be paid to the connection of the LED modules in series or in parallel depending upon the product specifications, always respecting the correct polarities. Do not connect switches to the secondary circuit.

### Reihen- oder Parallelschaltung von LEDs

Vor der Installation oder Wartung der Mind-Led-Produkte muss stets die Stromversorgung der Anlage ausgeschaltet werden. Die Anlage wird erst an den Strom angeschlossen, wenn alle Produkte und das Zubehör ordnungsgemäß angeschlossen wurden. Bei Reihen- oder Parallelschluss der LED-Module ist entsprechend der Spezifikationen des Produkts größte Sorgfalt anzuwenden und die Polarität stets einzuhalten. Schalter nicht an den Sekundärstromkreis anschließen.

### Branchement des LED en série ou en parallèle

Couper toujours l'électricité de l'équipement avant d'effectuer l'installation ou l'entretien des produits Mind-led. L'équipement sera branché au réseau uniquement lorsque tous les produits et accessoires auront été mis en place. Prêter la plus grande attention à l'installation des modules L.E.D. en série ou en parallèle, selon les spécificités du produit et en respectant toujours les polarités. Ne jamais brancher d'interrupteurs sur le circuit secondaire.

### Conexión de los LED en serie o en paralelo

Desconectar siempre la energía eléctrica del equipo antes de efectuar la instalación o el mantenimiento de los productos Mind-led. El equipo se tiene que alimentar sólo cuando todos los productos y accesorios se han conectado de forma oportuna. Prestar la máxima atención a la conexión de los módulos L.E.D. en serie o en paralelo según las especificaciones del producto, respetando siempre las polaridades. No conectar interruptores en el circuito secundario.

### Ligação dos LED em série ou em paralelo

Desligar sempre a energia elétrica da instalação antes de realizar a instalação ou a manutenção dos produtos Mind-led. A instalação deve ser alimentada quando todos os produtos e acessórios foram ligados oportunamente. Prestar a máxima atenção na conexão dos módulos L.E.D. em série ou em paralelo segundo as especificações do produto, respeitando sempre as polaridades. Não conectar interruptores no circuito secundário.

### Последовательное или параллельное подключение светодиодов

Всегда отключать электропитание системы перед установкой или техническим обслуживанием изделий Mind-led. Питание в систему должно подаваться только после надлежащего подключения всех изделий и аксессуаров. Обращать максимальное внимание на последовательное или параллельное подключение модулей светодиодов в зависимости от спецификаций изделия и с соблюдением полярности. Не подключать выключатель на вторичном контуре.

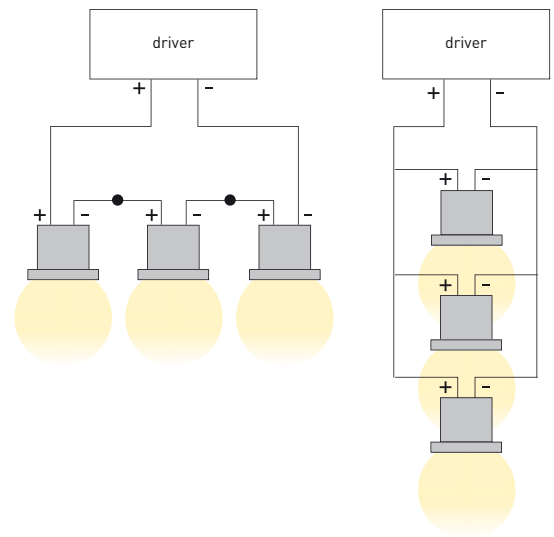

Collegamento in serie dei LED - solo corrente costante.  
Connection of the LEDs in series - only constant current.  
Reihen - Anschluss von LEDs nur an einer Konstantstromquelle.  
branchement en série des LED - uniquement courant constant.  
Conexión en serie de los LED - sólo corriente constante.  
Ligação em série dos LED - somente corrente constante.  
последовательное подключение светодиодов - только постоянный ток.  
**350/500/700/1000 mA**

Collegamento in parallelo dei LED - solo tensione costante.  
Connection of the LEDs in parallel - only constant voltage.  
Parallel - Anschluss von LEDs nur an einer Konstantspannungsquelle.  
Branchement en parallèle des LED - uniquement courant constant.  
Conexión en paralelo de los LED - sólo corriente constante.  
Ligação dos LED em paralelo - somente tensão constante.  
параллельное подключение светодиодов - только постоянное напряжение.  
**24 V dc**

# ACCESSORI / ACCESSORIES

## ALIMENTATORI / DRIVER

### 700 mA

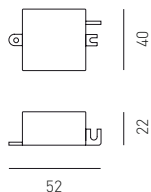

#### STANDARD

Code	W Max	Led 3 W	Led 6 W	Input	Output	Weight	Certification
CEDLTC00109	6	1-3	1	100-240 V 50-60 Hz	700mA cost. 12 V	35 gr.	CE IP20 RoHS

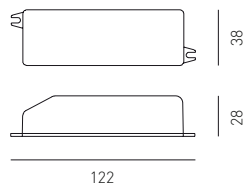

Code	W Max	Led 3 W	Led 6 W	Input	Output	Weight	Certification
CEDLTC00111	17	1-6	1-2	220-240 V 50-60 Hz	700mA cost. 27 V	106 gr.	CE IP20 RoHS

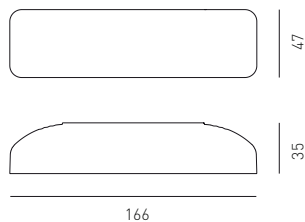

Code	W Max	Led 3 W	Led 6 W	Input	Output	Weight	Certification
CEDLTC00112	32	3-9	1-5	220-240 V 50-60 Hz	700mA cost. 46 Vmax	185 gr.	CE IP20 RoHS

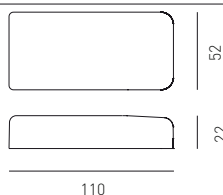

#### DIMMABLE 1-10V

Code	W Max	Led 3 W	Led 6 W	Input	Output	Weight	Certification
CEDLTC00113	20	1-6	1-3	110-240 V 50-60 Hz	700mA cost. 28 Vmax	80 gr.	CE IP20 RoHS

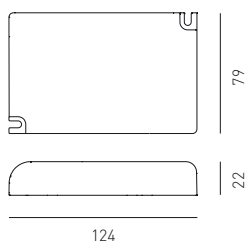

Code	W Max	Led 3 W	Led 6 W	Input	Output	Weight	Certification
CEDLTC00114	50	1-16	1-8	110-240 V 50-60 Hz	700mA cost. 70 Vmax	150 gr.	CE IP20 RoHS

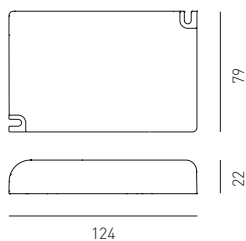

#### DALI

Code	W Max	Led 3 W	Led 6 W	Input	Output	Weight	Certification
CEDLTC00104	50	1-16	1-8	110-240 V 50-60 Hz	700mA cost. 70 Vmax	150 gr.	CE IP20 RoHS

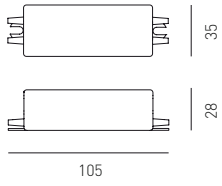

**IP 67**

Code	W Max	Led 3 W	Led 6 W	Input	Output	Weight	Certification
CEDLLG00307	12	1-4	1-2	120-240 V 50-60 Hz	700mA cost. 2-18 V	181 gr.	CE <b>IP67</b>  <b>RoHS</b>

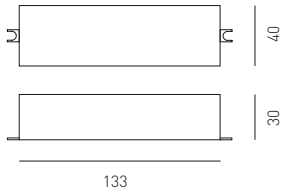

Code	W Max	Led 3 W	Led 6 W	Input	Output	Weight	Certification
CEDLLG00308	36	1-12	1-6	220-240 V 50-60 Hz	700mA cost. 4-52 V	280 gr.	CE <b>IP67</b>  <b>RoHS</b>





# LEGEND

LEGENDA LEGENDE LÉGENDE LEYENDA  
LEGENDA УСЛОВНЫЕ ОБОЗНАЧЕНИЯ



I nostri prodotti sono tutti sottoposti alle prove di sicurezza elettrica e conformi alle Direttive Comunitarie Europee EN60598-1, LVD 2006/95/EC, EMC 2004/108/EC (ove previsto).

All our products undergo electric safety tests and comply with ECC Directive EN60598-1, LVD 2006/95/EC, EMC 2004/108/EC (where provided).

Entsprechend den Europäischen Normen EN60598-1, LVD 2006/95/EC, EMC 2004/108/EC (sofern vorgesehen), werden alle Produkte den elektrischen Sicherheitsprüfungen unterzogen.

Tous nos produits sont soumis aux tests de sécurité, et sont conformes aux Directives CEE EN60598-1, LVD 2006/95/EC, EMC 2004/108/EC (le cas échéant).

Todos nuestros productos han sido sometidos a las pruebas de seguridad eléctrica y son conformes con las directivas comunitarias europeas EN60598-1, LVD 2006/95/EC, EMC 2004/108/EC (en los casos previstos).

Os nossos produtos são todos submetidos aos testes de segurança elétrica e conformes às Diretivas Comunitárias Europeias EN60598-1, LVD 2006/95/EC, EMC 2004/108/EC (se previsto).

Все наши изделия проходят испытания на электрическую безопасность и соответствуют директивам Европейского Сообщества EN60598-1, LVD 2006/95/EC, EMC 2004/108/EC (в случаях, когда это предусмотрено).



Prodotto conforme alle norme di sicurezza europee certificato Intertek.

Product in conformity with Intertek certificate for European safety standards.

Das Produkt entspricht den europäischen Sicherheitsrichtlinien, Intertek-Zertifizierung.

Produit conforme aux normes de sécurité européennes certifié Intertek.

El producto cumple con las normas de seguridad europeas, certificado Intertek.

Produzido de conformidade com as normas de segurança europeias certificado Intertek

Изделие соответствует европейским стандартам безопасности и имеет сертификат Intertek.



Apparecchio con tecnologia LED  
Device with LED technology  
Gerät mit LED-Technologie  
Dispositif à technologie LED  
Aparato con tecnología LED  
Aparelho com tecnologia LED  
Прибор со светодиодной технологией



Driver incluso nel prodotto  
Power supply unit included  
Treiber im Produkt inbegriffen  
Driver inclus dans le produit  
Driver incluido en el producto  
Unidade de abastecimento de potência incluída no produto  
Блок питания включен в комплект



**DIMMER**  
Predisposto con variatore di luce  
With dimmer  
Mit Dimmer  
Avec dimmer  
Con dimmer  
Predisposto com variador de luz  
Предусмотрено с диммер



Dimmerabile solo con driver dedicato  
Dimmable only with dedicated power supply unit  
Nur mit dem vorgesehenen Treiber dimmbar  
Dimmerable uniquement avec driver spécifique  
Regulable sólo con driver específico  
Atenuável somente com unidade de abastecimento de potência dedicada  
Регулировка яркости возможна только со специальным блоком питания



Prodotto da interni  
Indoor product  
Produkt für den Innenbereich  
Produit d'intérieur  
Producto para interiores  
Produto para interiores  
Изделие для внутренней установки



Prodotto da esterni con grado di protezione IPXY elevato  
Outdoor products with high IPXY protection  
Produkt für den Außenbereich mit hohem IPXY-Schutzgrad  
Produit pour l'extérieur au niveau de protection IPXY élevé  
Producto para exteriores grado de protección IPXY elevado  
Produto para exteriores com grau de proteção IPXY elevado  
Изделие наружной установки с высокой степенью защиты IPXY

## IPXY

Grado di protezione contro corpi solidi X – e contro i liquidi Y  
Protection rating against solid bodies X – against liquids Y  
Schutzgrad X gegen feste Körper – Schutzgrad Y gegen Flüssigkeiten  
Niveau de protection contre corps solides X – et contre les liquides Y  
Grado de protección contra cuerpos sólidos X – y contra los líquidos Y  
Grau de proteção contra corpos sólidos X – e contra os líquidos Y  
Степень защиты от проникновения твердых тел X и жидкостей Y



Peso lordo in Kg del prodotto  
Gross Kg weight of the product  
Bruttogewicht des Produkts in kg  
Poids brut en Kg du produit  
Peso bruto en Kg del producto  
Peso bruto do produto em Kg  
Полная масса изделия в кг



Apparecchio calpestabile  
Walk over device  
Gerät ist begehbar  
Appareil piétinable  
Aparato pisable a pie  
Aparelho que pode ser pisado  
Прибор, пригодный для хождения



Apparecchio carrabile a kg...  
Device can withstand weights up to kg...  
Gerät kann mit ... kg befahren werden  
Appareil carrossable à kg ...  
Aparato transitabile hasta ... kg  
Aparelho carroçável com kg...  
Прибор может выдерживать вес до ... кг



Luce ruotabile  
Rotable light  
Licht drehbar  
Lumière pivotante  
Luz giratoria  
Luz rotativa  
Поворачиваемый свет



Dimensioni foro per l'incasso  
Recessed hole dimension  
Maße des Einbauausschnitts  
Dimensions trous pour l'encastrement  
Tamaño orificio para el empotrado  
Medidas furo para o encaixe  
Размер отверстия для встраивания



**CLASSE 1**  
Solo isolamento fondamentale; le parti conduttrici accessibili sono collegate ad un conduttore di terra. Messa a terra obbligatoria.  
Basic insulation, accessible conductors are earthed. Earthing is compulsory.  
Grundisolation: berührbare Metallteile mit Anschlussstelle für Schutzleiter verbunden. Netzschutzleiter: vorgeschrieben.  
Isolation de base: les parties conductrices accessibles sont mises à terre. Mise à terre obligatoire.  
Solo aislamiento fundamental; las partes conductoras accesibles están conectadas a un conductor de tierra. Puesta a tierra obligatoria.  
Somente isolamento fundamental; as partes condutoras acessíveis são conectadas em um condutor de terra. Aterramento obrigatório.  
"Изоляция только базовая. Доступные проводниковые части подсоединены к заземлителю. Заземление обязательно.



**CLASSE 2**  
Sistema a doppio isolamento; messa a terra esclusa.  
Double insulation. Earthing: excluded.  
Doppelte Isolierung. Netzschutzleiter: nicht erlaubt.  
Double isolation. Mise à terre: exclue.  
Sistema de doble aislamiento; puesta a tierra no incluida.  
Sistema com isolamento duplo; aterramento excluído.  
Система двойной изоляции. Заземление исключено.



### CLASSE 3

Apparecchio in cui la protezione contro la scossa elettrica si basa sulla alimentazione a bassissima tensione di sicurezza.

Appliance in which protection against electrical shock is guaranteed by the extremely low-voltage power supply.

Zum Schutz vor elektrischen Schlägen mit Niedervolt gespeistes Gerät.

Appareil avec protection contre les décharges électriques basée sur l'alimentation à une tension de sécurité très basse.

Aparato en el cual la protección contra la descarga eléctrica se debe a la alimentación a muy baja tensión.

Aparelho no qual a proteção contra choque elétrico baseia-se na alimentação com baixíssima tensão de segurança.

Прибор, в котором защита от удара током основана на питании от очень низкого напряжения.

### RoHS

Apparecchio conforme alla normativa RoHS 2002/95/CE (Restriction of Hazardous Substances Directive)

Device conforms to the RoHS 2002/95/CE (Restriction of Hazardous Substances Directive)

Das Gerät entspricht der Norm RoHS 2002/95/CE (Restriction of Hazardous Substances Directive)

Appareil conforme à la réglementation RoHS 2002/95/CE (Restriction of Hazardous Substances Directive)

El aparato cumple con la normativa RoHS 2002/95/CE (Restriction of Hazardous Substances Directive)

Aparelho conforme à norma RoHS 2002/95/CE (Restriction of Hazardous Substances Directive)

Прибор соответствует требованиям RoHS 2002/95/EC (Директива об ограничении опасных веществ)

### ADA

Prodotto conforme alla normativa USA A.D.A. (protruding objects).

Product conforms to the USA A.D.A. standards (protruding objects).

Das Produkt entspricht der US-Norm USA A.D.A. (protruding objects)

Produit conforme à la norme USA A.D.A. (protruding objects).



Producto conforme con la normativa USA A.D.A. (protruding objects).





Produto conforme à norma USA A.D.A. (protruding objects).

Изделие соответствует требованиям стандарта США A.D.A. (выступающие объекты).

# LEGEND

LEGENDA LEGENDE LÉGENDE LEYENDA  
 LEGENDA УСЛОВНЫЕ ОБОЗНАЧЕНИЯ

			
<b>Tipologia</b>	<b>1</b> Lampada LED a parete	<b>2</b> Sospensione a LED	<b>3</b> Lampada LED a soffitto
<b>Type</b>	LED wall light	LED suspended light	LED ceiling luminaire
<b>Typ</b>	LED-Wandleuchte	LED-Hängeleuchte	LED-Deckenleuchte
<b>Typologie</b>	Applique LED	Suspension LED	Plafonnier LED
<b>Tipología</b>	Lámpara LED de pared	Suspensión de LED	Lámpara LED de techo
<b>Tipo</b>	Luminária LED de parede	Pendente com LED	Luminária LED de teto
<b>ТИП</b>	настенный светодиодный светильник	подвесной светодиодный светильник	потолочный светодиодный светильник

				
<b>Variante</b>	<b>0</b> Versione standard	<b>1</b> Variante singola	<b>2</b> Variante decentrata 1 luce	<b>4</b> Variante ad incasso
<b>System compatibility description</b>	Standard version	Monopoint canopy version	Decentralized version 1 light	Recessed version
<b>Variantenbeschreibung</b>	Standardvariante	Einzelvariante	Dezentrierte Variante mit 1 Lichtquelle	Einbauvariante
<b>Variante description</b>	Version standard	Variante individuelle	Variante décentrée 1 lumière	Variante encastrable
<b>Variante descripción</b>	Variante estándar	Variante individual	Variante descentrada 1 luz	Variante empotrable
<b>Versão descrição</b>	Versão padrão	Versão simples	Versão descentralizada 1 luz	Versão de encaixe
<b>описание варианта</b>	стандартная версия	одинарный вариант	смещенный вариант с 1 лампой	встраиваемый вариант

					
<b>Finitura</b>	<b>00</b> Finitura non dichiarata	<b>01</b> finitura cromo	<b>02</b> finitura argento anodizzato	<b>03</b> finitura acciaio INOX AISI316 satinato	<b>04</b> finitura verniciato nero opaco
<b>Finish</b>	Finishing not declared	chrome finish	silver anodized finish	AISI316 satin finish	painted black matt finish
<b>Ausführung</b>	Farbe nicht definiert	Verchromte Ausführung	Ausführung mit eloxiertem Silber	Ausführung in satiniertem INOX AISI316-Stahl	Mattschwarz lackierte Ausführung
<b>Finition</b>	Finition non déclarée	finition chrome	finition argent anodisé	finition acier INOX AISI316 satiné	finition verni noir opaque
<b>Acabado</b>	Acabado no declarado	acabado cromo	acabado plata anodizado	acabado acero inoxidable AISI316 satinado	acabado pintado negro mate
<b>Acabamento</b>	Acabamento não declarada	acabamento cromo	acabamento prata anodizada	acabamento aço INOX AISI316 acetinado	acabamento pintado preto fosco
<b>Отделка</b>	оотделка не сообщена	отделка хром	отделка анодированное серебро	отделка сатинированная сталь INOX AISI316	отделка окраской черной матовой краской





**5**  
Lampada da tavolo LED  
LED table lamp  
LED-Tischleuchte  
Lampe de table LED  
Lámpara LED de mesa  
Luminária de mesa LED  
настольный светодиодный светильник



**6**  
Proiettore LED  
LED spotlight  
LED-Projektor  
Projecteur LED  
Projector LED  
Spot LED  
светодиодный прожектор



**7**  
Incasso tecnico LED  
LED recessed downlight  
LED-Leuchte mit technischen Einbau  
Encastrement technique LED  
LED empotrable técnico  
Encaixe técnico LED  
технический встраиваемый светодиодный светильник



**8**  
Incasso decorativo LED  
LED recessed luminaire  
LED-Leuchte mit dekorativem Einbau  
Encastrement décoratif LED  
LED empotrable decorativo  
Encaixo decorativo LED  
декоративный встраиваемый светодиодный светильник



**9**  
Incasso calpestabile LED  
LED in-ground luminaire  
LED-Leuchte mit begehbarem Einbau  
Encastrement piétinable LED  
LED empotrable transitable a pie  
Encaixe de chão LED  
встраиваемый светодиодный светильник, пригодный для хождения



**6\***  
Variante per binario 220 V  
220 V track version  
Variante für Schienen  
Variante pour rail 220 V  
Variante para vía 220 V  
Versão para trilho 220 V  
вариант для установки на рельс 220 В



**7**  
Variante per rosone multiplo  
Multipoint canopy version  
Variante für Mehrfachrosetten  
Variante pour rosace multiple  
Variante para rosetón múltiple  
Versão para rosácea múltipla  
вариант для розетки на несколько светильников



**8**  
Variante monoemissione  
Monoemittig version  
Einzelstrahlvariante  
Variante mono-émission  
Variante monoemisión  
Versão mono-emissão  
однонаправленный вариант



**9**  
Variante biemissione  
Biemittig version  
Doppelstrahlvariante  
Variante bi-émission  
Variante biemisión  
Versão bi-emissão  
двунаправленный вариант

**\***  
L'adattatore GA69 è compatibile con i binari:  
The GA69 adapter is compatible with tracks from:  
Der Adapter GA69 ist kompatibel mit den Schienensystemen:  
L'adaptateur GA69 est compatible avec les rails:  
El adaptador GA69 es compatible con las guías:  
O adaptador GA69 é compatível com os binários:  
Адаптер GA69 совместим с шинпроводами:  
Global Trac, Erco, I-Guzzini, Eutrac, Hoffmeister, Nuco and Concord Lytespan 3.



**05**  
finitura verniciato grigio RAL 9007 raggrinzato  
painted grey RAL 9007 wrinkled finish  
RAL-9007 grau lackierte gefälte Ausführung  
finition verni gris RAL 9007 plissé  
acabado pintado gris RAL 9007 rugoso  
acabamento pintado cinza RAL 9007 enrugado  
отделка фактурная окраской серой краской RAL 9007



**06**  
finitura verniciato bianco RAL 9016 raggrinzato  
painted white RAL 9016 wrinkled finish  
RAL-9016 weiß lackierte gefälte Ausführung  
finition verni blanc RAL 9016 plissé  
acabado pintado blanco RAL 9016 rugoso  
acabamento pintado branco RAL 9016 enrugado  
отделка фактурная окраской белой краской RAL 9016



**07**  
finitura verniciato bianco RAL 9016 opaco  
painted white RAL 9016 matt finish  
RAL-9016 mattweiß lackierte gefälte Ausführung  
finition verni blanc RAL 9016 opaque  
acabado pintado blanco RAL 9016 mate  
acabamento pintado branco RAL 9016 fosco  
отделка фактурная окраской белой краской RAL 9016





**08**  
nero opaco  
matt black  
mattschwarz  
noir opaque  
negro mate  
preto fosco  
черная матовая



**09**  
bianco opaco  
matt white  
mattweiß  
blanc opaque  
blanco mate  
branco fosco  
белая матовая

# LEGEND

LEGENDA LEGENDE LÉGENDE LEYENDA  
 LEGENDA УСЛОВНЫЕ ОБОЗНАЧЕНИЯ

	0	 3000K	 4000K
<b>Temperatura Colore LED</b>	senza led	1 luce calda	3 luce naturale
<b>LED Colour Temperature</b>	no led	warm light temperature	natural light temperature
<b>Temperatur Farbiges LEDs</b>	ohne Led	warmes Licht	natürliches Licht
<b>Température Couleur LED</b>	sans led	lumière chaude	lumière naturelle
<b>Temperatura Color LED</b>	sin led	luz cálida	luz natural
<b>Temperatura Cor LED</b>	sem led	luz quente	luz natural
<b>Температура Света Светодиодов</b>	без светодиодов	теплый свет	естественный свет

	0	 10°	 25°	 60°	
<b>Fascio Luminoso</b>	senza lente	1 Fascio stretto	2 fascio medio	3 fascio largo	4 fascio diffuso
<b>Beam Options</b>	no lens	narrow beam	medium beam	large beam	diffused beam
<b>Lichtstrahl</b>	ohne Linse	schmaler Strahl	mittlerer Strahl	breiter Strahl	diffuser Strahl
<b>Faisceau Lumineux</b>	sans verre	faisceau étroit	faisceau moyen	faisceau large	faisceau diffus
<b>Haz Luminoso</b>	sin lente	haz estrecho	haz medio	haz ancho	haz difuso
<b>Feixe Luminoso</b>	sem lente	feixe estreito	feixe médio	feixe largo	feixe difuso
<b>Полоса Света</b>	без линзы	узкая полоса	средняя полоса	широкая полоса	рассеянная полоса



5000K

5

luce fredda

cool light temperature

kaltes Licht

lumière froide

luz fría

luz fria

холодный свет



5

fascio regolabile

adjustable beam

einstellbarer Strahl

faisceau réglable

haz regulable

feixe regulável

регулируемая полоса



6

fascio combinato  
largo+stretto

large+narrow  
combined beam

kombinierter Strahl  
breit+schmal

faisceau combiné large+étroit

haz combinado  
ancho+estrecho

feixe combinado  
largo+estrito

комбинированная  
широкая+узкая полоса

Axo Light si riserva il diritto di apportare ai modelli, senza alcun preavviso, qualsiasi modifica ritenesse opportuna. Axo Light non risponde per eventuali danni a persone o cose causati da una non corretta installazione dei propri apparecchi d'illuminazione. I dati riportati sono puramente indicativi; è possibile che siano riportati degli errori di stampa.

Axo Light reserves itself the right to introduce any changes to its own models, without prior notice. Axo Light is not liable for injuries or damage due to the incorrect installation of its fixtures. The details given here are intended purely as guidance as errors may have occurred during the printing process.

Axo Light behält sich das Recht vor, jederzeit und ohne Voranmeldung, Änderungen der Kollektion vorzunehmen, ohne jedoch die charakteristischen Eigenschaften der Artikel zu ändern. Axo Light ist nicht verantwortlich für eventuelle Personen- oder Sachschäden, verursacht durch unsachgemäße Installation der Produkte. Aufgrund möglicher Druckfehler, sind die angegebenen Daten lediglich als Richtwerte zu verstehen.

Axo Light se réserve le droit de modifier ses collections à tous moments et sans préavis, dans le respect des caractéristiques de base du produit. Axo Light ne répond pas aux éventuels dommages à personnes ou choses causés par une mauvaise installation de ses appareils d'éclairage. Les coordonnées mentionnées sont purement indicatives; il est possible que des erreurs d'impression y figurent.

Axo Light se reserva el derecho de aportar a los propios modelos, sin ningún preaviso, cualquier modificación que se considere oportuna. Axo Light no responde por los eventuales daños causados a personas o cosas provocados por una incorrecta instalación de los propios aparatos de iluminación. Los datos que aparecen son puramente indicativos; es posible que contengan errores de impresión.

Axo Light reserva-se o direito de efetuar nos modelos, sem nenhum pré-aviso, qualquer modificação que considerar oportuna. Axo Light não responde por eventuais danos a pessoas ou coisas causados por uma instalação incorreta dos próprios aparelhos de iluminação. Os dados reproduzidos são meramente indicativos; é possível que estejam indicados erros de impressão.

Axo Light оставляет за собой право вносить модификации моделей без предупреждения, в случае необходимости. Axo Light не несёт ответственности за ущерб людям или вещам, вызванный некорректной установкой осветительных приборов. Приведенные данные носят иллюстративный характер; возможны опечатки.

#### **Misure dei disegni in mm**

**Measures of the drawings in mm**

**Maße der Zeichnungen in mm**

**Dimensions des dessins en mm**

**Tamaño de los dibujos en mm**

**Medidas dos desenhos em mm**

**размеры на рисунках в мм**

Le schede tecniche dei prodotti Axo Light sono scaricabili direttamente dal nostro sito:

**[www.axolight.it](http://www.axolight.it)**

Axo Light technical sheets can be downloaded directly from our website:

**[www.axolight.it](http://www.axolight.it)**

Die Axo Light Produktdatenblätter können direkt von unserer Website heruntergeladen werden:

**[www.axolight.it](http://www.axolight.it)**

Les fiches techniques des produits Axo Light peuvent être téléchargés directement de notre site:

**[www.axolight.it](http://www.axolight.it)**

Las fichas técnicas de los productos Axo Light se pueden descargar directamente de nuestro sitio web:

**[www.axolight.it](http://www.axolight.it)**

As fichas técnicas dos produtos Axo Light podem ser baixadas diretamente do nosso site:

**[www.axolight.it](http://www.axolight.it)**

Технические характеристики изделий фирмы Axo Light возможно скачать с нашего сайта:

**[www.axolight.it](http://www.axolight.it)**