

arturo alvarez

emotional light

ASSEMBLY INSTRUCTIONS | INSTRUCCIONES DE MONTAJE

Box contains | Contenido de la caja:

A - Lampshade | Tulipas [3]

B - Canopy | Florón [1]

C - Frame | Soporte [1]

D - Cap | Tapón [3]

E - Screws | Tornillos [3]

F - Wall plug | Tacos [3]

G - Electrical disposal | Ficha conexión [1]

ref. **CA04A - 3**

Suitable for indoor use, at 25°C

Apta para uso interior a temperatura ambiente de 25°C

FRONTAL VIEW | VISTA FRONTAL

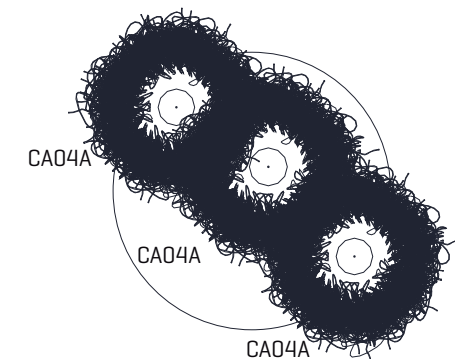
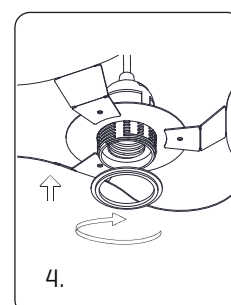
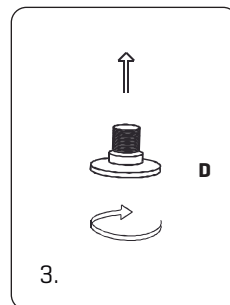
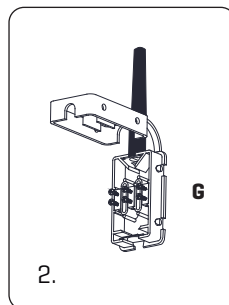
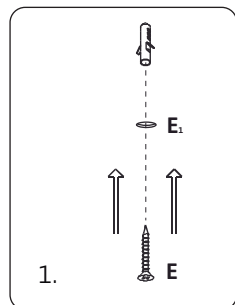
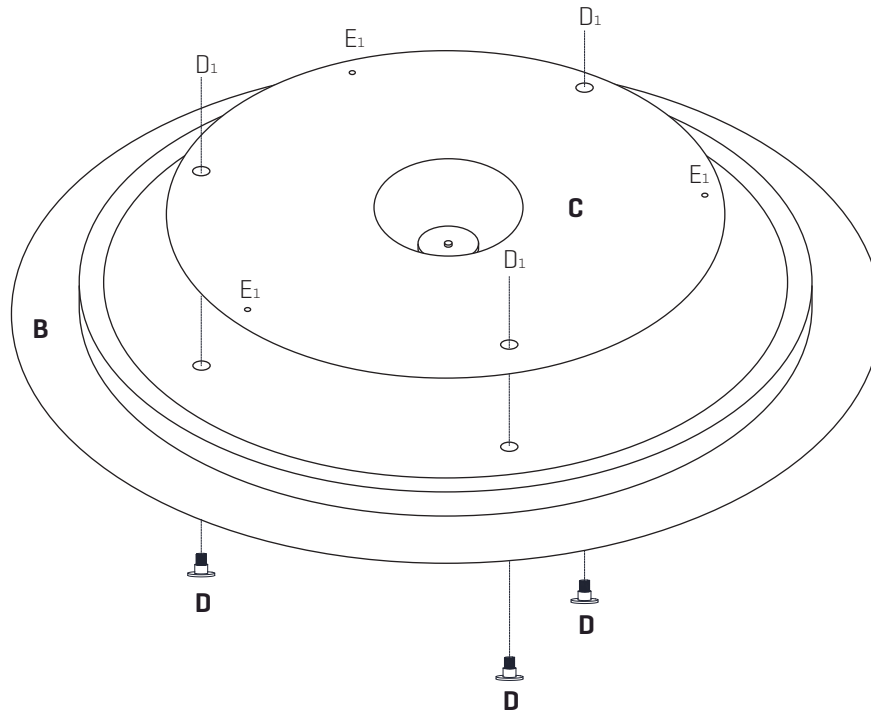

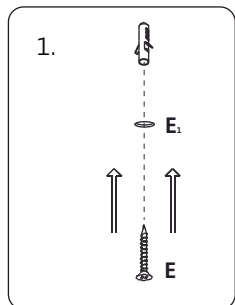

1. Make holes in the ceiling as marked in the frame with the letter E., insert the wall plugs and fix the frame.

* Our plugs are appropriate for concrete ceilings only

1. Hacer los taladros en su techo según los marcados en el soporte con la letra E., colocar los tacos y fijar el soporte.

* Nuestros tacos son sólo aptos para superficies de hormigón

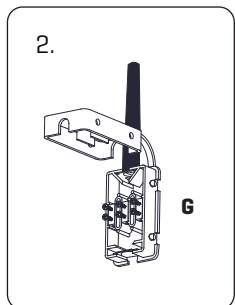

2. Pass the electrical wires inside the electrical disposal G.

The power cables from the wall shouldn't exceed the dimension of the black hose connection box provided, as shown in Fig. 2.1

Make the electrical connections taking care to respect the correct polarity as the color code.

2. Pasar los cables eléctricos al interior de la caja de conexiones G.

Los cables de alimentación procedentes de la pared no deben exceder la dimensión del manguito negro de la caja de conexiones suministrada, tal y como se indica en la figura 2.1

Realizar la conexión eléctrica teniendo cuidado de respetar la polaridad correcta según el código de colores.

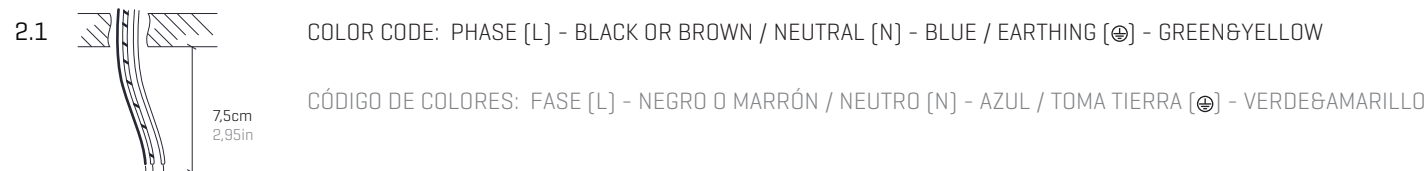

COLOR CODE: PHASE [L] - BLACK OR BROWN / NEUTRAL [N] - BLUE / EARTHING [⊕] - GREEN&YELLOW

CÓDIGO DE COLORES: FASE [L] - NEGRO O MARRÓN / NEUTRO [N] - AZUL / TOMA TIERRA [⊕] - VERDE&AMARILLO

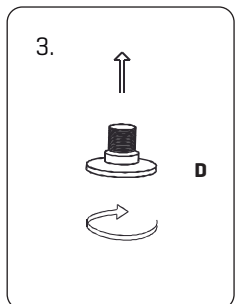

3. Once the frame is fixed, screw the caps in the holes marked with D.

3. Colocado el soporte, enroscar los tapones en los taladros marcados con la letra D.

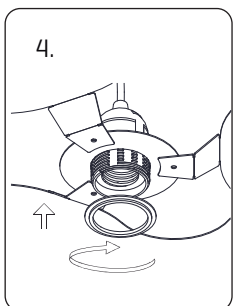

4. Insert the lampshade into the lampholder and tighten the nut.

4. Encajar la tulipa en el portalámparas y apretar la tuerca.

Box contains | Contenido de la caja:

- A** - Lampshade | Tulipas [3]
- B** - Canopy | Florón [1]
- C** - Frame | Soporte [1]
- D** - Cap | Tapón [3]

- E** - Screws | Tornillos [3]
- F** - Wall plug | Tacos [3]
- G** - Electrical disposal | Ficha conexión [3]

ref. **CA04A - 3**

Suitable for indoor use at 77°F
Apta para uso interior a temperatura ambiente de 77°F

FRONTAL VIEW | VISTA FRONTAL

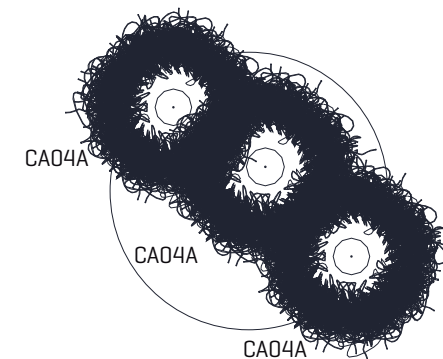
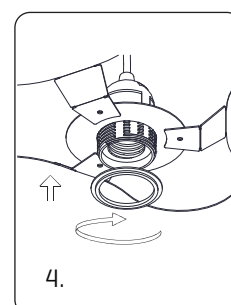
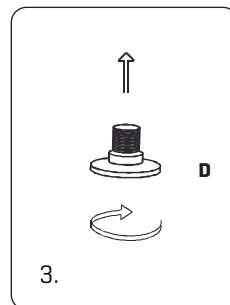
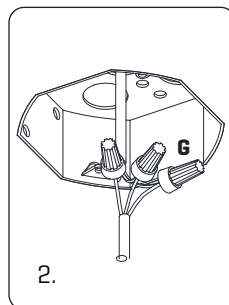
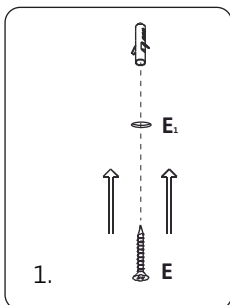
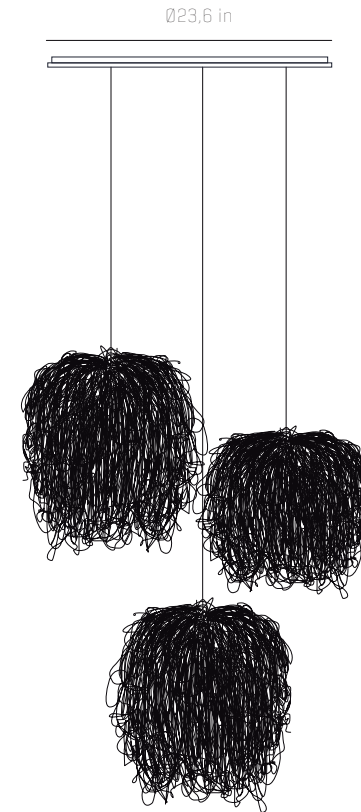
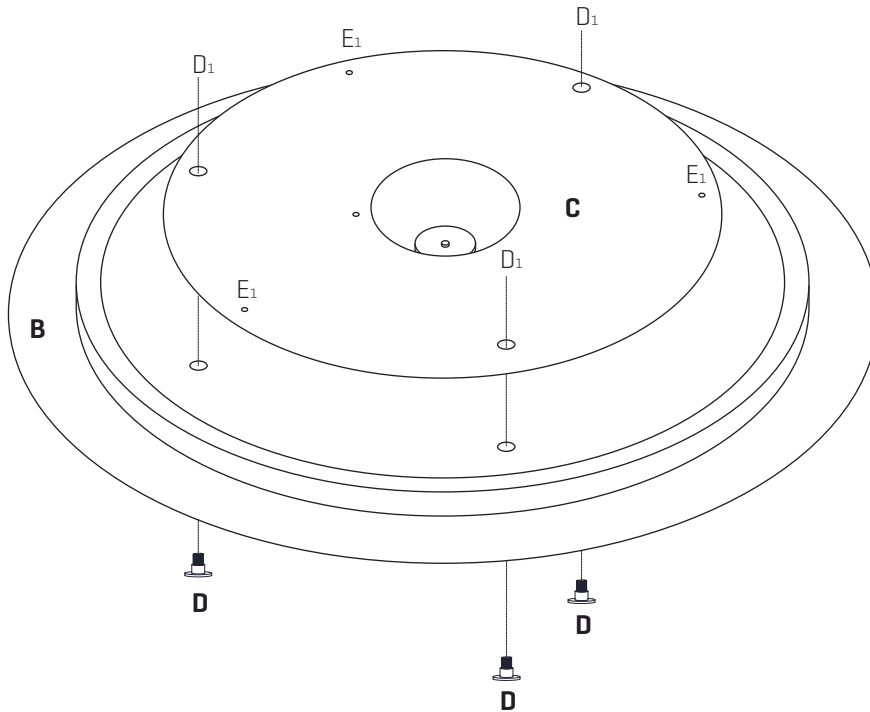

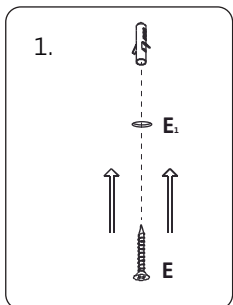

1. Make holes in the ceiling as marked in the frame with the letter E₁, insert the wall plugs and fix the frame.

* Our plugs are appropriate for concrete ceilings only

1. Hacer los taladros en el techo según los marcados en el soporte con la letra E₁, colocar los tacos y fijar el soporte.

* Nuestros tacos son sólo aptos para superficies de hormigón

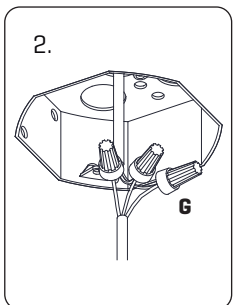

2. Pass the electrical wires inside the octagon box.

Make the electrical connections taking care to respect the correct polarity as the color code.

2. Pasar los cables eléctricos al interior de la caja de conexiones.

Realizar la conexión eléctrica en las fichas de conexión G teniendo cuidado de respetar la polaridad correcta según el código de colores.

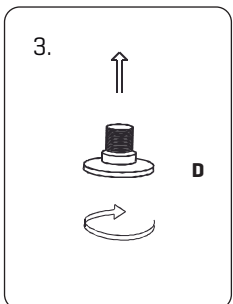

3. Once the frame is fixed, screw the caps in the holes marked with D₁.

3. Colocado el soporte, enroscar los tapones en los taladros marcados con la letra D₁.

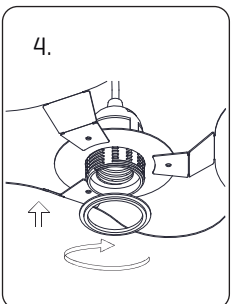

4. Insert the lampshade into the lampholder and tighten the nut.

4. Encajar la tulipa en el portalámparas y apretar la tuerca.