

# BLACK OUT floor lamp

Matteo Ugolini design

year 2015

## TECHNICAL SHEET - HP101 3B INT

### STRUCTURE "A"

material	metal	
colour	matt white	

### SHADE "B"

material	fiberglass	
colour	white	

### ELECTRICAL CABLE "C"

material	PVC	
colour	transparent	

### ELECTRICAL SYSTEM

socket	E27
source	max 1x105w
energy class	from E to A++





### PACKAGING

nr. of collis	1
net weight/kg	4,3
gross weight/kg	7,6
packaging/cm	80x80x70

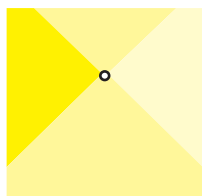
### EMISSION OF LIGHT

one-directional



	direct
	filtered
	indirect
	none

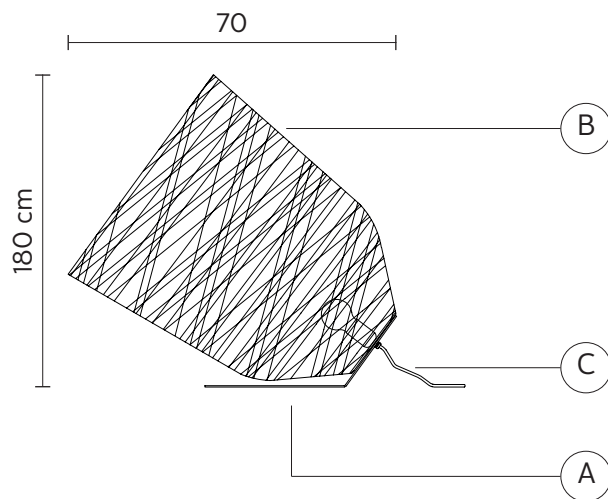

### CERTIFICATION

IEC	60598-1:2008
EN	60598-1:2008 + A11:2009



IP rate	IP20
bulb	not provided



code **700B**  
decorative bulb  
E27 - 25w - ≤ 60 lumen  
class E

### COLLECTION

available also as: suspension (in/outdoor)

