

QUADRANTE suspension

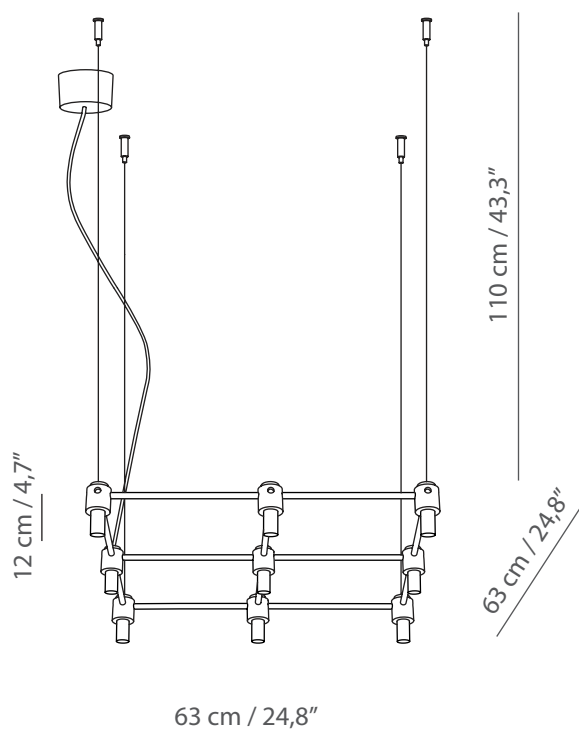

QUADRANTE / suspension lamp

Roberto Giacomucci designer

● **C74** Nero bucciato / Black rough

○ **C80** Bianco sabbia / Sand white

Sospensione/Suspension

code: **505.09**

L 63 W 63 H 12 cm

9 x MAX 10W - G9