

ESPECIFICACIONES TÉCNICAS / ACABADOS  
TECHNICAL DATA / FINISHED

**DAU SPOT / 4164**  
Flemming Bjorn

BL

Ø 80

H 162

1 x GU10 | 75 W. |  $\triangle 50^\circ$  |  Dim.

1 x GU10 | 5 W. | 210 lumens | 2800 K |  $\triangle 30^\circ$  | 

 | 

DESCRIPCIÓN  
DESCRIPTION

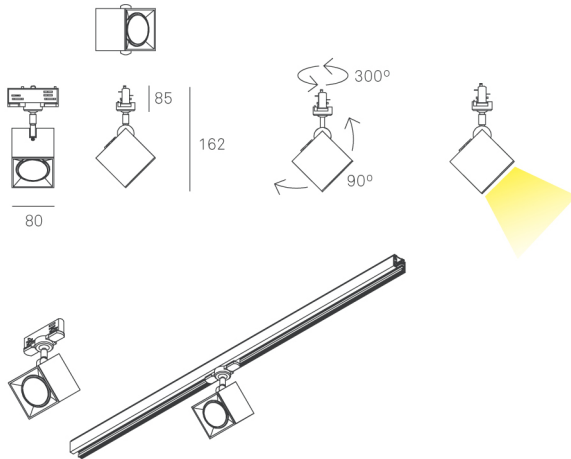
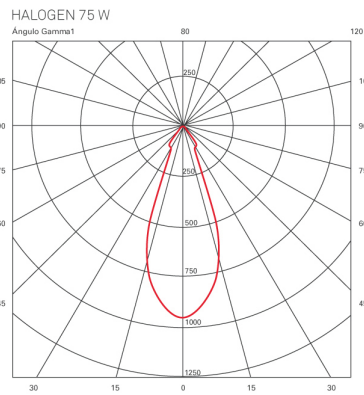
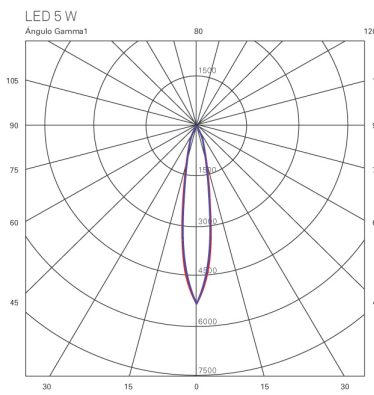

COMENTARIOS / COMMENTS