



Thanks for choosing LED Profilelement.

Please take the time to view the installation videos and read through the following instructions, as when installed properly this product looks the business!

### INSTALLATION VIDEOS



How To Fit LED Profilelement DSL Fitting

<https://youtu.be/bTs9JaCeKqw>



How To Fit LED Profilelement SNL Fitting

[https://youtu.be/\\_w\\_AEB8Sqe4](https://youtu.be/_w_AEB8Sqe4)

# DARKLIGHT DESIGN

## LED PROFILEMENT INSTALLATION INSTRUCTIONS

### GENERIC INSTALLATION INSTRUCTIONS - 1



01. Profiles are supplied in 2000mm lengths.

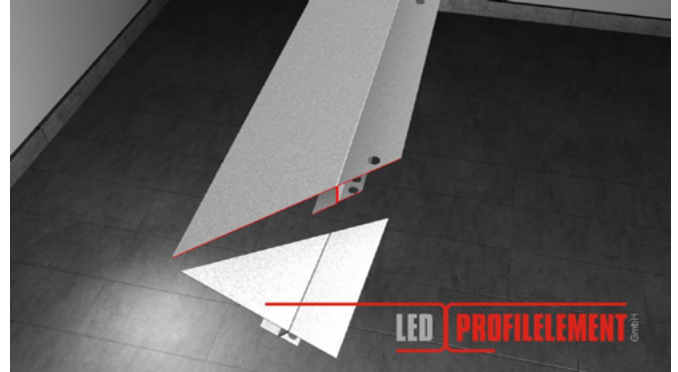

02. Cut the profile to measurement using a hand saw, jigsaw, angular grinder or a pair of snips.

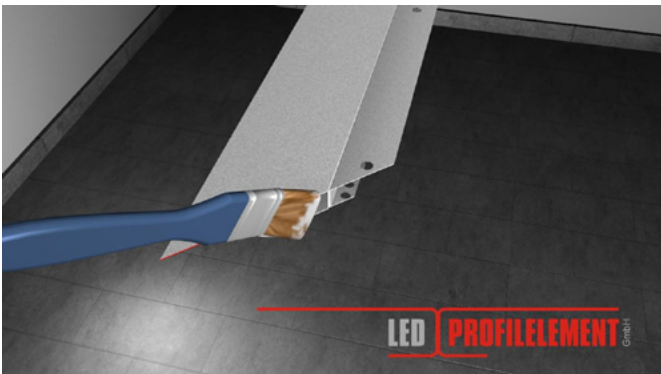

03. File or sand cut edges. Re-apply primer to the cut edges (e.g. standard zinc primer).



04. Drill the opening for the LED connecting electrical cables from above with a metal drill bit.

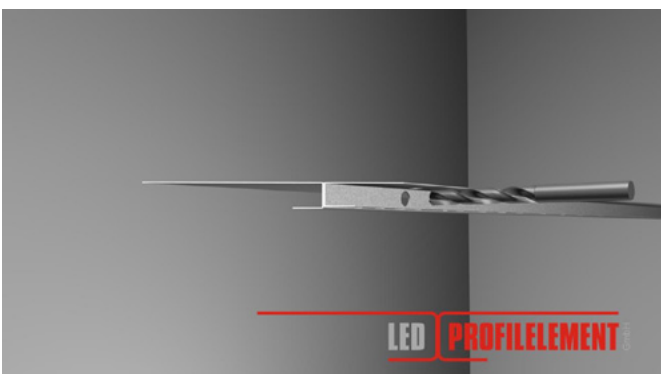

05. Drill the opening for the LED connecting electrical cables into the side of the profile.

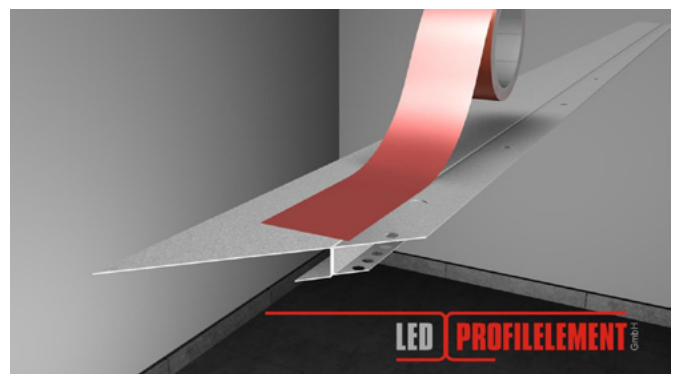

06. Apply double faced adhesive tape or construction adhesive to the profile for easier mounting.

# DARKLIGHT DESIGN

## LED PROFILEMENT INSTALLATION INSTRUCTIONS

### GENERIC INSTALLATION INSTRUCTIONS - 2

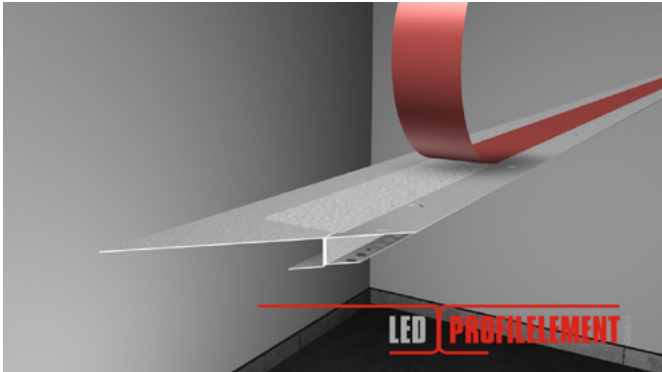

- 07.** Remove the protective foil from the adhesive tape (if using).



- 08.** Mount the profiles onto the wood or metal framework.

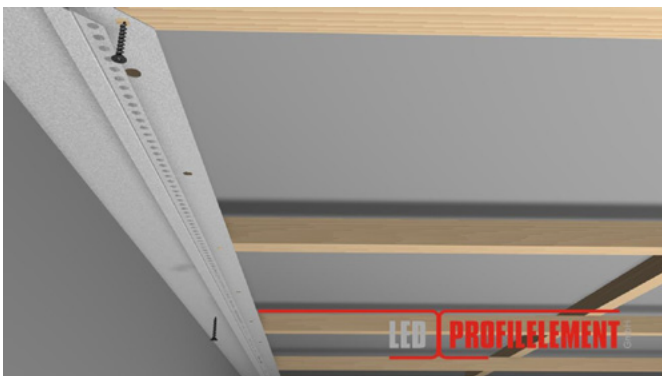

- 09.** Screw the profile to the framework using regular gypsum plasterboard screws.

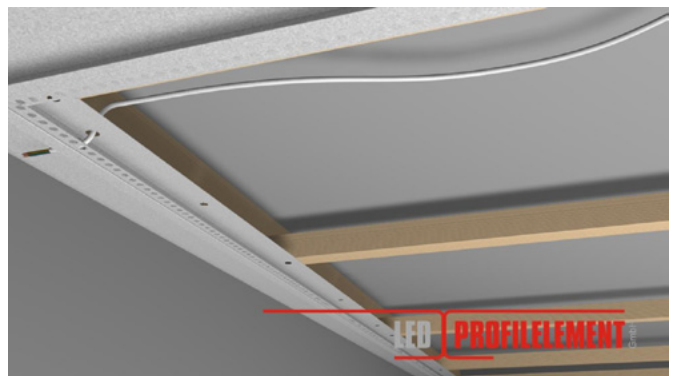

- 10.** Install the feeder cables at the supply points.

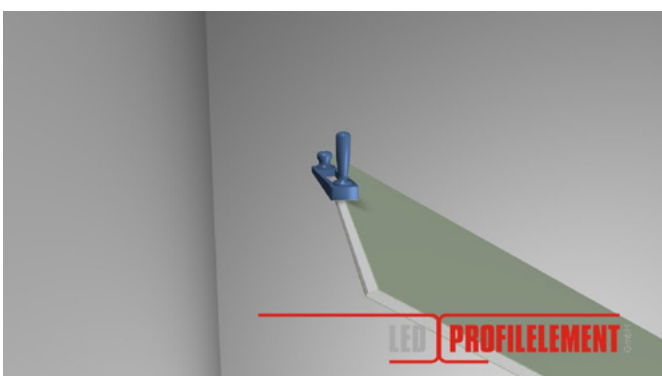

- 11.** Cut the gypsum boards to size and slide into the profiles.

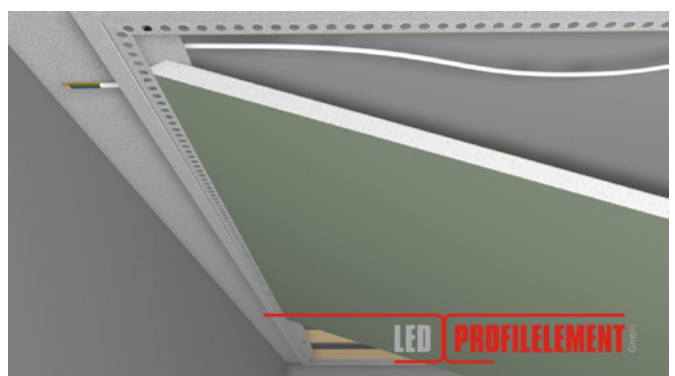

- 12.** Make a large notch in the gypsum board to allow access for the supply cable.

# DARKLIGHT DESIGN

## LED PROFILEMENT INSTALLATION INSTRUCTIONS

### GENERIC INSTALLATION INSTRUCTIONS - 3

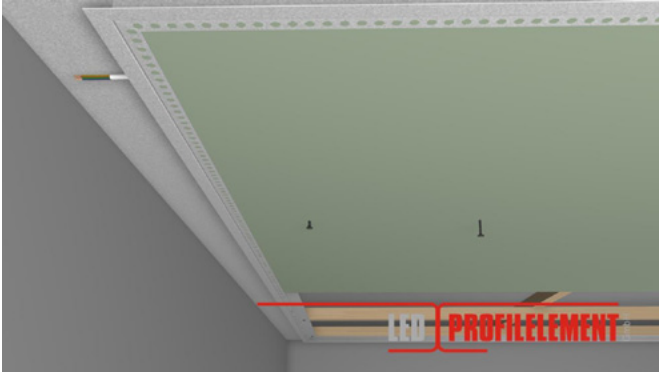

13. Screw down the gypsum boards according to the manufacturer's instructions.

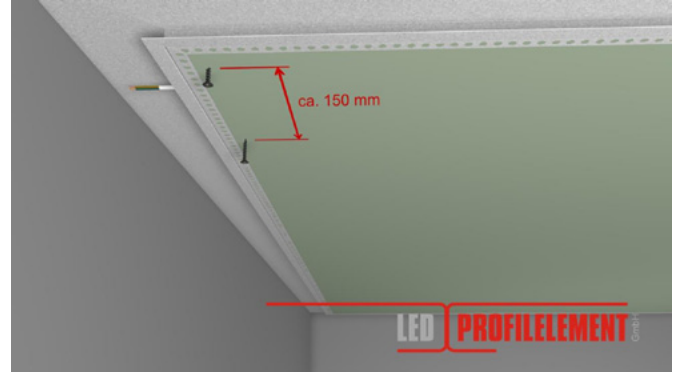

14. Screw the gypsum boards to the profiles leaving 150mm between each screw.

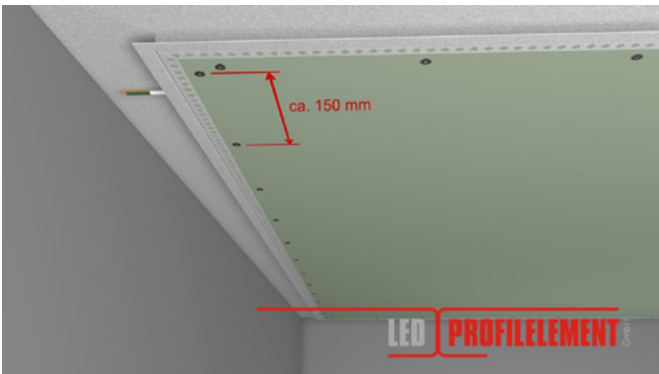

15. Fix screws along the edges of the profile. If necessary, cut off any screw tips that stick out of the back of the profile.

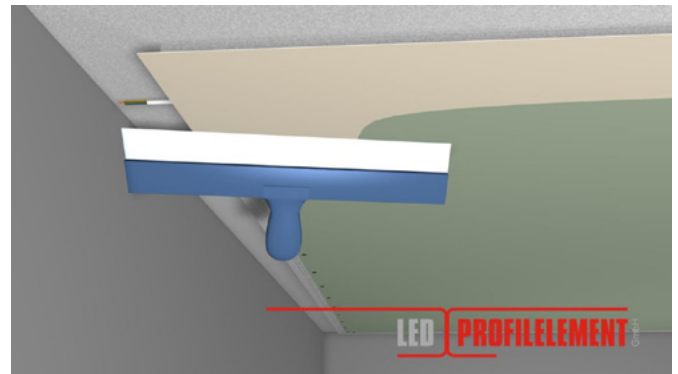

16. Pre-fill with regular filling compound.

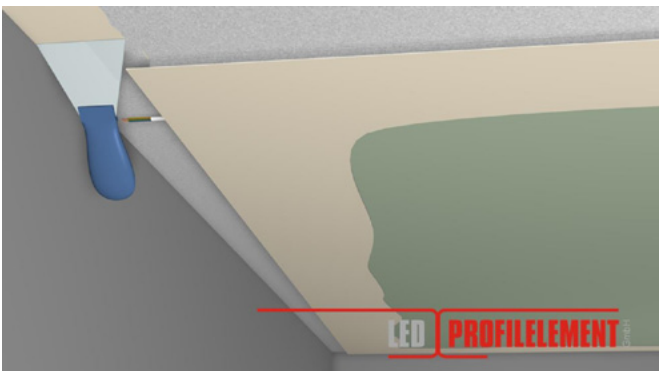

17. Fill all adjoining profile edges and screw fixings.



18. Attach the paintable fleece to the slotted metal profile in small strips with a brush and cold glue. Observe the drying time stated by the adhesive manufacturer.  
**\*The protective fleece MUST cover the profile from the edges up to the gypsum board\***

# DARKLIGHT DESIGN

## LED PROFILEMENT INSTALLATION INSTRUCTIONS

### GENERIC INSTALLATION INSTRUCTIONS - 4



19. After drying, repeat step 18 two or three times to ensure that the individual metal ribs do not show when illuminated and to create a non-transparent surface.

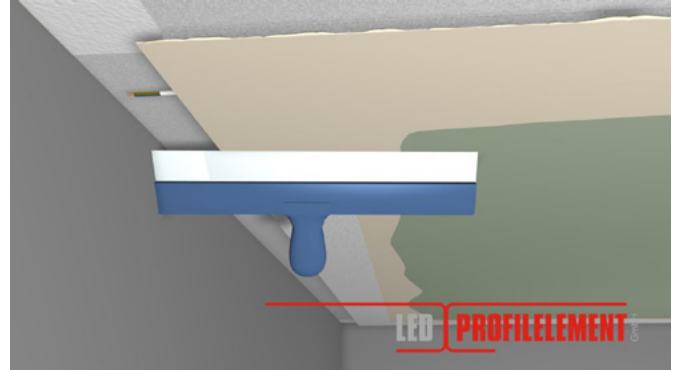

20. Once the fleece is dry, trim any that protrudes over the edge. Fill the fleece strip with standard filler.

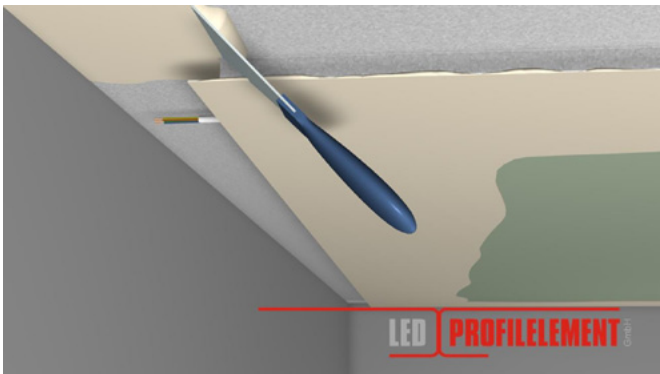

21. Remember to fill all adjoining edges and corners.

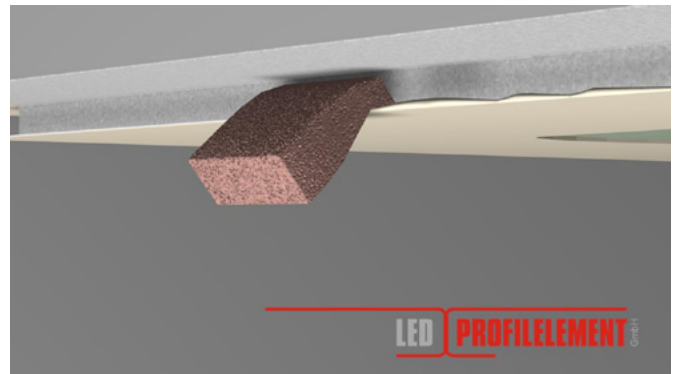

22. Remove surplus filler on the visible surface of the profile thoroughly. Failure to do so may cast shadows and waves on wall and ceiling.

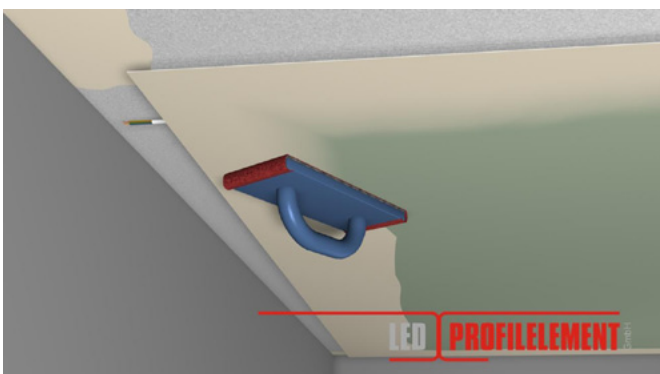

23. Sand back the filled profiles and surfaces. Avoid leaving an uneven surface that may break the light. Surface quality Q3 or Q4.

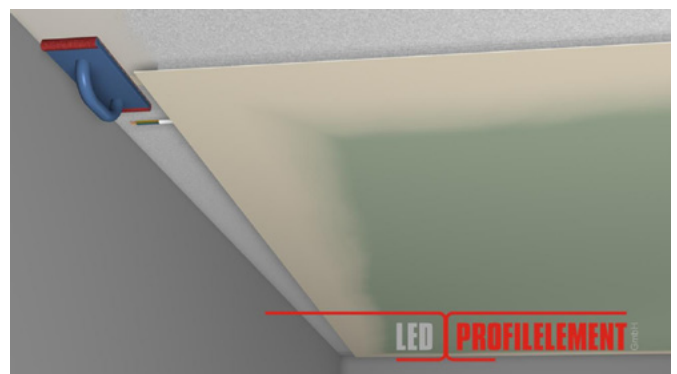

24. Sand back the filled corners. Surface quality Q3 or Q4.

# DARKLIGHT DESIGN

## LED PROFILELEMENT INSTALLATION INSTRUCTIONS

### GENERIC INSTALLATION INSTRUCTIONS - 5

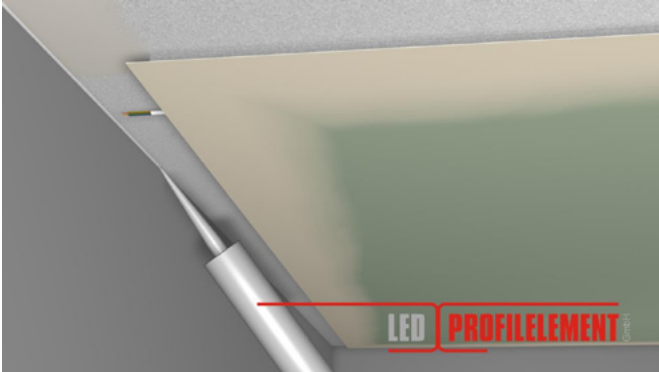

25. Clean the profiles and surfaces thoroughly of any surplus filler material and dust. If the profile touches the wall apply a clean line of acrylic adhesive.



26. Paint with standard gypsum board primer and finish with paint, plaster, wallpaper, etc.

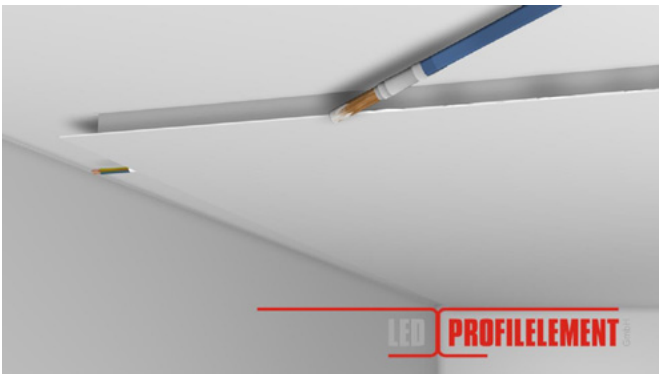

27. Lightly smooth and remove surplus paint or other undesired material from the edges of the profile.

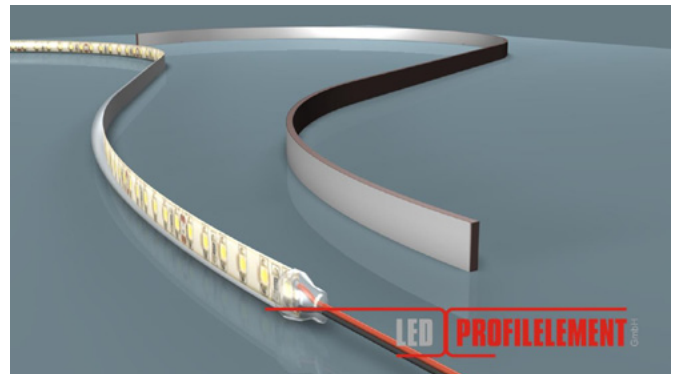

28. Apply the magnetic tape to the LED tape.

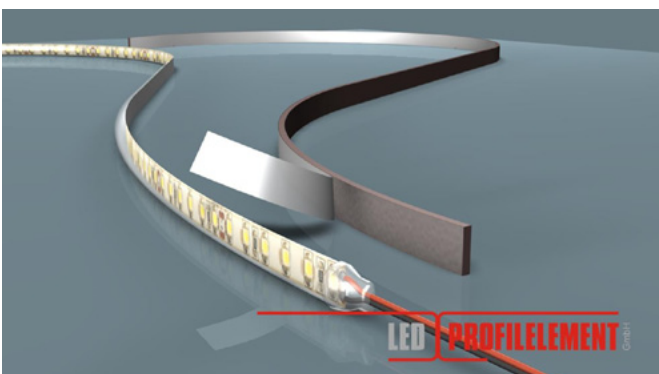

29. Remove the protective foils from both the magnetic tape and the LED tape.

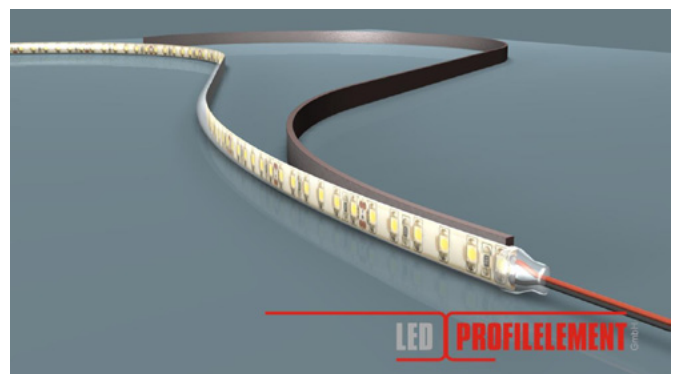

30. Fix the magnetic tape to the LED tape.

# DARKLIGHT DESIGN

## LED PROFILEMENT INSTALLATION INSTRUCTIONS

### GENERIC INSTALLATION INSTRUCTIONS - 6

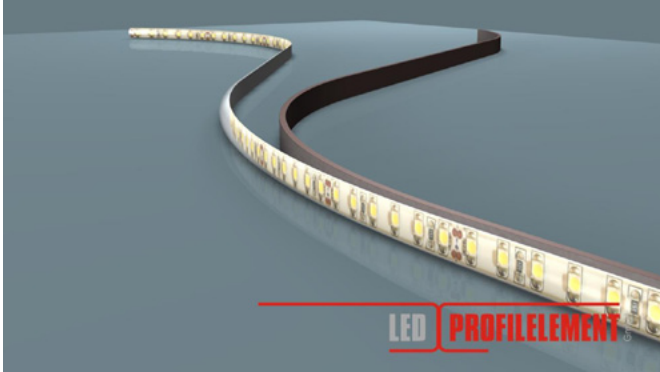

31. Continue down the length of the tapes.

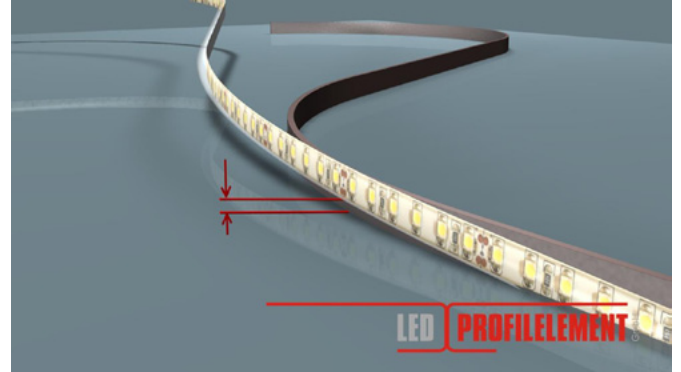

32. Ensure that the magnetic and LED tapes are fixed together perfectly with no creases and not out of line.

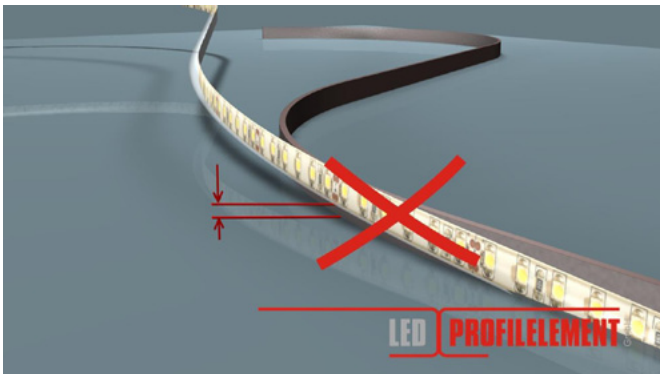

33. If fixed out of line, this will cause the light to be cast in an irregular way and create an unwanted effect.

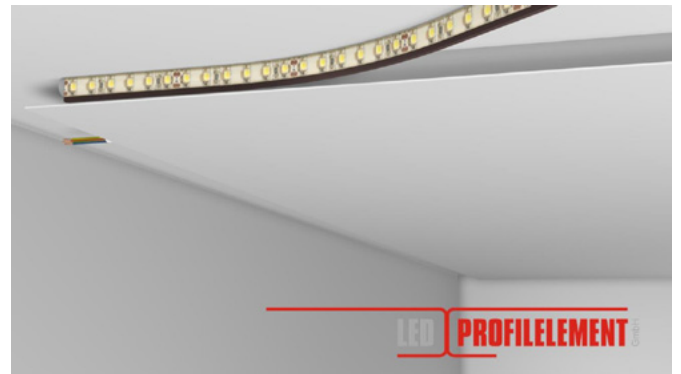

34. Once the magnetic and LED tapes are merged, insert into the recess of the profile.



35. Straighten out LED strip to create the perfect lighting effect.

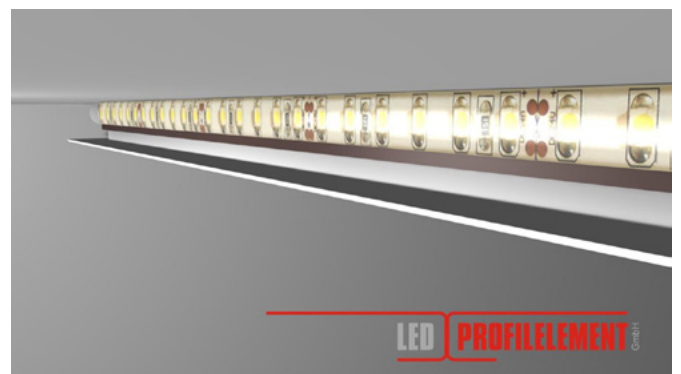

36. Your LED tape should look like the above image.

# DARKLIGHT DESIGN

## LED PROFILELEMENT INSTALLATION INSTRUCTIONS

### GENERIC INSTALLATION INSTRUCTIONS - 7



**37.** Fix any waves in the LED tape.



**38.** Leaving a kink in the LED tape will cast wave-like shadows.

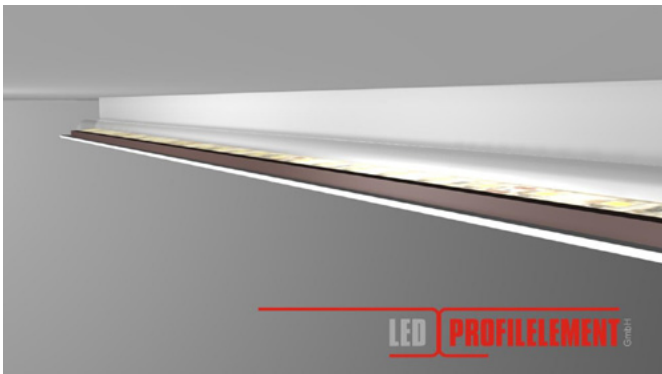

**39.** The LED tape can be installed on various faces of the profile, creating different lighting effects.

N.B. We recommend that you use the LED Profilelement diffuser where possible to avoid creating sharp, hard lines and to soften the light.

Diffuser not available for all profiles.

### DISCLAIMER

In the event of damage occurring to profiles as a result of incorrect installation, Darklight Design regrets that we are unable to offer an exchange or refund. It is the installer's responsibility to ensure that all equipment is installed correctly and in accordance with the specification, supplemented by the manufacturer's information.

We know you get it – thanks for bearing with us here.