



Power supplies and control systems

Alimentatori e sistemi di controllo

Alimentations électriques et systèmes de contrôle

Netzteile und Steuerungssysteme

Fuentes de alimentación y sistemas de control

Constant current power supplies non dimmable

Alimentatori in corrente costante non dimmerabili
Alimentations en courant Constant non dimmables
Konstantstrom-Netzteile nicht-dimmbare
Alimentadores en corriente constante no regulable

The constant current power supplies are suitable for a LED power supply. The wiring of the luminaires is standard. The amount of LEDs that can be powered by the power supply, indicated below the code, refers to the individual diodes and not the luminaires, which can fit more than one LED internally. The indication Sec Protection, if present, indicates the option of a wiring harness of the luminaires even when the power supply is live. If this indication is not present, it is necessary to make a wiring harness for the luminaires and supply power to the driver only after completing it.

Gli alimentatori in corrente costante sono idonei all'alimentazione di LED di potenza. Il cablaggio degli apparecchi è in serie. La quantità di LED alimentabili con l'alimentatore, indicata al di sotto del codice, fa riferimento ai singoli diodi e non agli apparecchi, che possono montare al proprio interno anche più di un LED. L'indicazione Sec. Protection, ove presente, indica la possibilità di effettuare il cablaggio degli apparecchi anche con l'alimentatore in tensione. Ove questa indicazione non sia presente, è necessario effettuare il cablaggio degli apparecchi e solamente dopo averlo completato fornire alimentazione al driver.

Les alimentateurs à courant constant sont adaptés pour l'alimentation de LED de puissance. Le câblage des appareils est en série. La quantité de LED pouvant être alimentés par alimentateur, indiquée sous le code, se réfère aux diodes individuelles et non aux appareils, qui peuvent être composés, à l'intérieur, de plusieurs LED. L'indication Sec. Protection, là où elle est présente, indique la possibilité d'effectuer le câblage des appareils même en cas d'alimentation en tension. Si cette indication n'est pas présente, il faut effectuer le câblage des appareils et seulement après l'avoir complété, fournir l'alimentation au driver.

Die Konstantstrom-Netzteile eignen sich zur Speisung von High Brightness LEDs. Die Verkabelung der Geräte ist serienmäßig. Die Menge der mit dem Netzteil zu speisenden LEDs, die unter dem Code genannt wird, bezieht sich auf die einzelnen Dioden und nicht auf die Geräte, die mehr als ein LED montieren können. Die Sec. Protection Hinweise, wo vorhanden, weisen auf die Möglichkeit hin, die Verkabelung der Geräte auch bei, unter Spannung stehenden Geräten, ausführen zu können. Sollten diese Hinweise nicht vorhanden sein, muss man die Verkabelung der Geräte ausführen und erst nach Abschluss der Arbeiten, den Driver speisen.

Los alimentadores en corriente constante son idóneos para la alimentación de LED de potencia. El cableado de los aparatos es en serie. La cantidad de LED alimentables con el alimentador, indicada por debajo del código, hace referencia a los diodos individuales y no a los aparatos, que pueden montar en su interior también más de un LED. La indicación Sec. Protection, donde esté presente, indica la posibilidad de efectuar el cableado de los aparatos también con el alimentador en tensión. Donde esta indicación no esté presente, es necesario efectuar el cableado de los aparatos y solamente tras haberlo completado suministrar alimentación al controlador.

Wiring Diagram

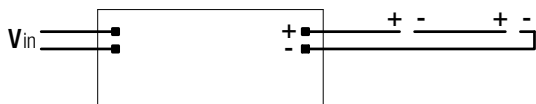

Schema di cablaggio - Schéma de câblage
Schaltplan - Diagrama de cableado







140 mA

	AL9014 45 mm IP65	Potenza Power Puissance Bestuekung Potencia	Alimentazione Input voltage Alimentation Speisung Alimentación	V out max	Dimensioni Dimensions Größe Dimensiones
		6 W	220..240 VAC	43 V	85x39x19 (h)





250 mA

	AL1025 40 mm IP20	Potenza Power Puissance Bestuekung Potencia	Alimentazione Input voltage Alimentation Speisung Alimentación	V out max	Dimensioni Dimensions Größe Dimensiones
		10 W	220..240 VAC	43 V	115x34x19 (h)
	AL9025 45 mm IP65	Potenza Power Puissance Bestuekung Potencia	Alimentazione Input voltage Alimentation Speisung Alimentación	V out max	Dimensioni Dimensions Größe Dimensiones
		10 W	220..240 VAC	43 V	85x39x19 (h)

350 mA

	AL1034 30 mm IP20	Potenza Power Puissance Bestuekung Potencia	Alimentazione Input voltage Alimentation Speisung Alimentación	V out max	Dimensioni Dimensions Größe Dimensiones
		15 W	220..240 VAC	43 V	142x22x19 (h)
	AL1035 40 mm IP20	Potenza Power Puissance Bestuekung Potencia	Alimentazione Input voltage Alimentation Speisung Alimentación	V out max	Dimensioni Dimensions Größe Dimensiones
		15 W	220..240 VAC	43 V	115x34x19 (h)
	AL1037 55 mm IP20	Potenza Power Puissance Bestuekung Potencia	Alimentazione Input voltage Alimentation Speisung Alimentación	V out max	Dimensioni Dimensions Größe Dimensiones
		19 W	220..240 VAC	57 V	120x52x22 (h)
	AL9011 60 mm IP67	Potenza Power Puissance Bestuekung Potencia	Alimentazione Input voltage Alimentation Speisung Alimentación	V out max	Dimensioni Dimensions Größe Dimensiones
		18 W	220..240 VAC	43 V	120x40x31 (h)

500 mA

	AL1074 30 mm IP20	Potenza Power Puissance Bestuekung Potencia	Alimentazione Input voltage Alimentation Speisung Alimentación	V out max	Dimensioni Dimensions Größe Dimensiones
		14 W	220..240 VAC	28 V	142x22x19 (h)
	AL1077 40 mm IP20	Potenza Power Puissance Bestuekung Potencia	Alimentazione Input voltage Alimentation Speisung Alimentación	V out max	Dimensioni Dimensions Größe Dimensiones
		15 W	220..240 VAC	24 V	115x34x19 (h)
	AL1084 55 mm IP20	Potenza Power Puissance Bestuekung Potencia	Alimentazione Input voltage Alimentation Speisung Alimentación	V out max	Dimensioni Dimensions Größe Dimensiones
		20 W	220..240 VAC	40 V	120x52x22 (h)
	AL9051 60 mm IP67	Potenza Power Puissance Bestuekung Potencia	Alimentazione Input voltage Alimentation Speisung Alimentación	V out max	Dimensioni Dimensions Größe Dimensiones
		21 W	220..240 VAC	35 V	120x40x31 (h)
	AL9052 50 mm IP67	Potenza Power Puissance Bestuekung Potencia	Alimentazione Input voltage Alimentation Speisung Alimentación	V out max	Dimensioni Dimensions Größe Dimensiones
		20 W	220..240 VAC	40 V	110x38x23 (h)

750 mA

	AL1087 90 mm IP20	Potenza Power Puissance Bestuekung Potencia	Alimentazione Input voltage Alimentation Speisung Alimentación	V out	Dimensioni Dimensions Größe Dimensiones
		50 W	220..240 VAC	10..66 V	129x76x30 (h)

1050 mA

	AL1083 90 mm IP20	Potenza Power Puissance Bestuekung Potencia	Alimentazione Input voltage Alimentation Speisung Alimentación	V out	Dimensioni Dimensions Größe Dimensiones
		50 W	220..240 VAC	10..48 V	129x76x30 (h)

Dimmable Constant current power supplies

Alimentatori in corrente costante dimmerabili
 Alimentations en courant Constant dimmables
 Konstantstrom-Netzteile dimmbare
 Alimentadores en corriente constante regulable

The constant current power supplies are suitable for a LED power supply. The wiring of the luminaires is standard. The amount of LEDs that can be powered by the power supply, indicated below the code, refers to the individual diodes and not the luminaires, which can fit more than one LED internally. The procedure to manage the dimming are given in the indications: PUSH - management via a button that is normally open; 1-10V - management via signal 1..10V; DALI - management via DALI signal.

Gli alimentatori in corrente costante sono idonei all'alimentazione di LED di potenza. Il cablaggio degli apparecchi è in serie. La quantità di LED alimentabili con l'alimentatore, indicata al di sotto del codice, fa riferimento ai singoli diodi e non agli apparecchi, che possono montare al proprio interno anche più di un LED. Le modalità di gestione della dimmerazione sono segnalate dalle indicazioni: PUSH - gestione tramite pulsante normalmente aperto; 1-10V - gestione tramite segnale 1..10V; DALI - gestione tramite segnale DALI.

Les alimentateurs à courant constants sont adaptés pour l'alimentation de LED de puissance. Le câblage des appareils est en série. La quantité de LED pouvant être alimentés par alimentateur, indiquée sous le code, se réfère aux diodes individuelles et non aux appareils, qui peuvent être composés, à l'intérieur, de plusieurs LED. Les modalités de gestion de la variation d'intensité sont indiquées par les indications: PUSH - gestion via bouton normalement ouvert; 1-10V - gestion via signal 1..10V; DALI - gestion via signal DALI.

Die Konstantstrom-Netzteile eignen sich zur Speisung von High Brightness LEDs. Die Verkabelung der Geräte ist serienmäßig. Die Menge der mit dem Netzteil zu speisenden LEDs, die unter dem Code genannt wird, bezieht sich auf die einzelnen Dioden und nicht auf die Geräte, die mehr als ein LED montieren können. Auf die Dimm-Modalitäten weisen die folgenden Hinweise hin: PUSH - Steuerung mit einem normalerweise offenem Taster; 1-10V - Steuerung über Signal 1..10V; DALI - Steuerung über DALI Signal.

Los alimentadores en corriente constante son idóneos para la alimentación de LED de potencia. El cableado de los aparatos es en serie. La cantidad de LED alimentables con el alimentador, indicada por debajo del código, hace referencia a los diodos individuales y no a los aparatos, que pueden montar en su interior también más de un LED. Las modalidades de gestión de la regulación están señaladas por las indicaciones: PUSH - gestión mediante botón normalmente abierto; 1-10V - gestión mediante señal 1..10V; DALI - gestión mediante señal DALI.

Wiring Diagram

Schema di cablaggio - Schéma de câblage
 Schaltplan - Diagrama de cableado

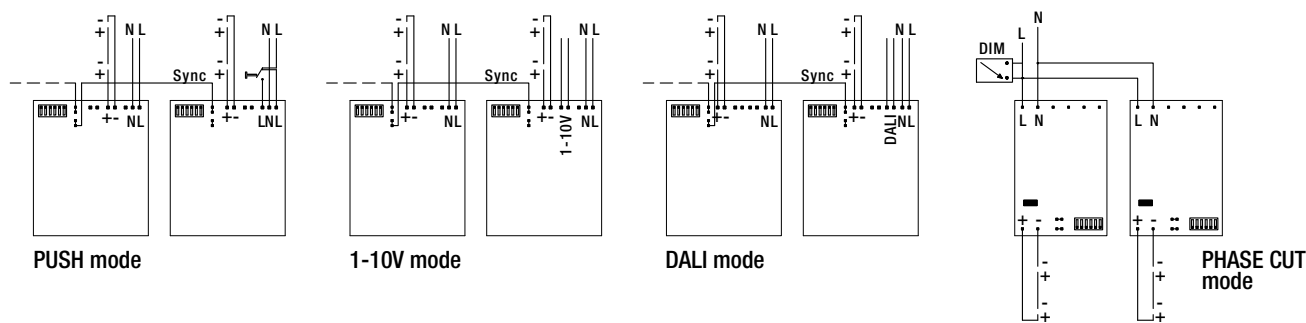

250 mA



AL4030

1-10V



Potenza
Power
Puissance
Bestuekung
Potencia

14 W

Alimentazione
Input voltage
Alimentation
Speisung
Alimentación

220..240 VAC

V out max

55 V

Dimensioni
Dimensions
Größe
Dimensiones

111x52x22 (h)



AL4031

DALI



Potenza
Power
Puissance
Bestuekung
Potencia

10 W

Alimentazione
Input voltage
Alimentation
Speisung
Alimentación

220..240 VAC

V out max

43 V

Dimensioni
Dimensions
Größe
Dimensiones

111x52x22 (h)



AL4032

IGBT-TRIAC



Potenza
Power
Puissance
Bestuekung
Potencia

10 W

Alimentazione
Input voltage
Alimentation
Speisung
Alimentación

220..240 VAC







V out max

43 V







Dimensioni
Dimensions
Größe
Dimensiones

111x52x22 (h)





350 mA

	AL4000 PUSH 1-10V  IP20	Potenza Power Pouissance Bestuekung Potencia	Alimentazione Input voltage Alimentation Speisung Alimentación	V out max 43 V	Dimensioni Dimensions Größe Dimensiones	Sincronizzabili Synchronizable Synchronisable Synchronisierbar Sncronizable	Cavetto sincronizzazione Synchronization cable Câble de synchronisation Synchronisationskabel Cable de sincronización
	AL4051 DALI  IP20	Potenza Power Pouissance Bestuekung Potencia	Alimentazione Input voltage Alimentation Speisung Alimentación	V out max 43 V	Dimensioni Dimensions Größe Dimensiones	Sincronizzabili Synchronizable Synchronisable Synchronisierbar Sncronizable	Cavetto sincronizzazione Synchronization cable Câble de synchronisation Synchronisationskabel Cable de sincronización
	AL4053 PUSH IGBT-TRIAC  IP20	Potenza Power Pouissance Bestuekung Potencia	Alimentazione Input voltage Alimentation Speisung Alimentación	V out max 47 V	Dimensioni Dimensions Größe Dimensiones		





500 mA

	AL4010 PUSH 1-10V  IP20	Potenza Power Pouissance Bestuekung Potencia	Alimentazione Input voltage Alimentation Speisung Alimentación	V out max 43 V	Dimensioni Dimensions Größe Dimensiones	Sincronizzabili Synchronizable Synchronisable Synchronisierbar Sncronizable	Cavetto sincronizzazione Synchronization cable Câble de synchronisation Synchronisationskabel Cable de sincronización
	AL4151 DALI  IP20	Potenza Power Pouissance Bestuekung Potencia	Alimentazione Input voltage Alimentation Speisung Alimentación	V out max 43 V	Dimensioni Dimensions Größe Dimensiones	Sincronizzabili Synchronizable Synchronisable Synchronisierbar Sncronizable	Cavetto sincronizzazione Synchronization cable Câble de synchronisation Synchronisationskabel Cable de sincronización
	AL4153 PUSH IGBT-TRIAC  IP20	Potenza Power Pouissance Bestuekung Potencia	Alimentazione Input voltage Alimentation Speisung Alimentación	V out max 47 V	Dimensioni Dimensions Größe Dimensiones		

750 mA

	AL4730 PUSH 1-10V  IP20	Potenza Power Pouissance Bestuekung Potencia	Alimentazione Input voltage Alimentation Speisung Alimentación	V out max 66 V	Dimensioni Dimensions Größe Dimensiones	Sincronizzabili Synchronizable Synchronisable Synchronisierbar Sncronizable	Cavetto sincronizzazione Synchronization cable Câble de synchronisation Synchronisationskabel Cable de sincronización
	AL4731 DALI  IP20	Potenza Power Pouissance Bestuekung Potencia	Alimentazione Input voltage Alimentation Speisung Alimentación	V out max 66 V	Dimensioni Dimensions Größe Dimensiones	Sincronizzabili Synchronizable Synchronisable Synchronisierbar Sncronizable	Cavetto sincronizzazione Synchronization cable Câble de synchronisation Synchronisationskabel Cable de sincronización

1050 mA

	AL4040 PUSH 1-10V  IP20	Potenza Power Pouissance Bestuekung Potencia	Alimentazione Input voltage Alimentation Speisung Alimentación	V out max 48 V	Dimensioni Dimensions Größe Dimensiones	Sincronizzabili Synchronizable Synchronisable Synchronisierbar Sncronizable	Cavetto sincronizzazione Synchronization cable Câble de synchronisation Synchronisationskabel Cable de sincronización
	AL4041 DALI  IP20	Potenza Power Pouissance Bestuekung Potencia	Alimentazione Input voltage Alimentation Speisung Alimentación	V out max 48 V	Dimensioni Dimensions Größe Dimensiones	Sincronizzabili Synchronizable Synchronisable Synchronisierbar Sncronizable	Cavetto sincronizzazione Synchronization cable Câble de synchronisation Synchronisationskabel Cable de sincronización

Constant Voltage power supplies

Alimentatori in tensione costante

Alimentations en tension constant

Konstantspannung-Netzteile

Fuentes de alimentación de voltaje constante

Gli alimentatori in tensione costante sono idonei all'alimentazione di apparecchi a 24VDC. Il cablaggio degli apparecchi è in parallelo.

Constant voltage power supplies are suitable for powering 24VDC luminaires. The wiring of the luminaires is in parallel.

Les alimentateurs en tension constante sont adaptés pour l'alimentation d'appareils à 24VDC. Le câblage des appareils est en parallèle.

Die Konstantspannungs-Netzteile eignen sich zur 24VDC Speisung der Geräte. Die Verkabelung der Geräte wird parallel geschaltet.

Los alimentadores en tensión constante son idóneos para la alimentación de aparatos a 24VDC. El cableado de los aparatos es en paralelo.

Wiring Diagram

Schema di cablaggio - Schéma de câblage

Schaltplan - Diagrama de cableado

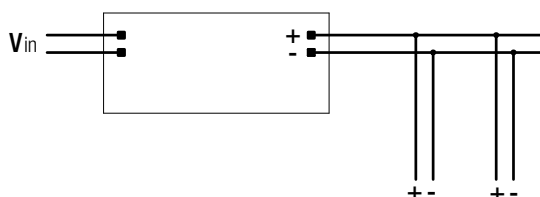

24 VDC

		Potenza Power Puissance Bestuekung Potencia	Alimentazione Input voltage Alimentation Speisung Alimentación	I out max	Dimensioni Dimensions Größe Dimensiones
	AL2012 60 mm IP20	25 W	220..240 VAC	1040 mA	146x55x19 (h)
	AL2031 70 mm IP20	70 W	220..240 VAC	2900 mA	225x60x36 (h)
	AL2040 80 mm IP20	150 W	220..240 VAC	6250 mA	240x60x49 (h)
	AL9212 IP68	20 W	220..240 VAC	830 mA	105(d)x74 (h)
	AL9231 IP67	70 W	220..240 VAC	2900 mA	268x66x51 (h)
	AL9240 IP67	150 W	220..240 VAC	6250 mA	268x66x51 (h)

Constant Voltage dimming systems

Sistemi per la dimmerazione in tensione costante

Systèmes de dimmage en tension constant

Konstantspannung Dimm-Systeme

Sistemas para la regulación en tensión constante

The dimming systems allow you to adjust brightness. The procedure to manage the dimming are given in the indications: PUSH - management via a button that is normally open; 1-10V - management via signal 1..10V; DALI - management via DALI signal. Each control element can be associated with up to 10 slave modules. The capacity of each module corresponds to the associated supply, up to a maximum of 10 A.

I sistemi di dimmerazione permettono la regolazione della luminosità. Le modalità di gestione della dimmerazione sono segnalate dalle indicazioni: PUSH – gestione tramite pulsante normalmente aperto; 1-10V – gestione tramite segnale 1..10V; DALI – gestione tramite segnale DALI. Ogni elemento di comando può essere associato a massimo 10 moduli slave. La portata di ogni modulo corrisponde a quella dell'alimentatore associato, fino ad un massimo di 10 A.

Les systèmes de variation d'intensité permettent de régler la luminosité. Les modalités de gestion de la variation d'intensité sont indiquées par les indications: PUSH – gestion via bouton normalement ouvert; 1-10V – gestion via signal 1..10V; DALI – gestion via signal DALI. Chaque élément de commande peut être associé à un maximum de 10 modules slave. La portée de chaque module correspond à celle de l'alimentateur associé, jusqu'à un maximum de 10 A.

Mithilfe der Dimm-Systeme kann man die Lichtstärke steuern. Auf die Dimm-Modalitäten weisen die folgenden Hinweise hin: PUSH – Steuerung mit einem normalerweise offenem Taster; 1-10V – Steuerung über Signal 1..10V; DALI – Steuerung über DALI Signal. Jedes Steuerelement kann maximal mit 10 Slave-Modulen verbunden werden. Die Stromfähigkeit jedes Moduls entspricht der des damit verbundenen Netzteils, bis maximal 10 A.

Los sistemas de regulación permiten la regulación de la luminosidad. Las modalidades de gestión de la regulación están señaladas por las indicaciones: PUSH – gestión mediante botón normalmente abierto; 1-10V – gestión mediante señal 1..10V; DALI – gestión mediante señal DALI. Cada elemento de mando se puede asociar a un máximo de 10 módulos esclavos. La capacidad de cada módulo corresponde a la del alimentador asociado, hasta un máximo de 10 A.

Wiring Diagram

Schema di cablaggio - Schéma de câblage

Schaltplan - Diagrama de cableado

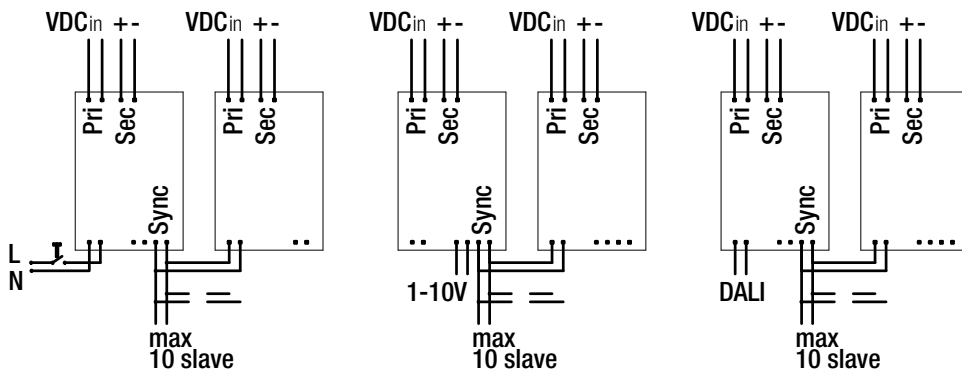

AL7035

PUSH

1-10V

DALI

**IP20
master/slave**

Tensione di Alimentazione
Input voltage
Tension d'alimentation
Versorgungsspannung
tensión de alimentación

12..24 VDC

I out max

10 A

Dimensioni
Dimensions
Größe
Dimensiones

156x52x26 (h)

Voltage/Current converters

Convertitori tensione/corrente costante

Convertisseur tension/courant constant

Konverter Spannung/Konstantstrom

Convertidores de tensión constante /corriente constante

The converters allow you to make constant voltage lines from 12 to 48 VDC to those which connect in parallel. The power supplied depends on the supply voltage, to define the capacity, you can consider an absorption of 3,6 V per powered LED. The wiring downstream of the converters must be made in series, it is also necessary to make a wiring harness for the luminaires and supply power to the driver only after completing it.

I convertitori consentono di realizzare linee in tensione costante da 12 a 48 VDC alle quali vengono collegati in parallelo. La potenza erogata è funzione della tensione di alimentazione, per definire la portata si può considerare un assorbimento di 3,6 V per LED alimentato. Il cablaggio a valle dei convertitori deve essere fatto in serie, è inoltre necessario effettuare il cablaggio degli apparecchi e solamente dopo averlo completato fornire alimentazione al driver.

Les convertisseurs permettent de réaliser des lignes de tension constante de 12 à 48 VDC auxquelles ils sont reliés en parallèle. La puissance distribuée est en fonction de la tension d'alimentation; pour définir la portée, on peut considérer une absorption de 3,6 V par LED alimenté. Le câblage, en aval des convertisseurs, doit être fait en série, en outre, il faut effectuer le câblage des appareils et seulement après l'avoir complété, fournir l'alimentation au driver.

Mit den Transformatoren kann man Linien mit Konstantstromspannung von 12 bis 48 VDC verwirklichen, an die sie parallel geschaltet werden. Die Abgabeleistung richtet sich nach der Speisungsspannung, zur Definition der Stromfähigkeit kann man eine Aufnahme von 3,6 V ja LED annehmen. Die nachgeschaltete Verkabelung der Transformatoren muss in Reihe durchgeführt werden

Los convertidores permiten realizar líneas en tensión constante de 12 a 48 VDC a las cuales se conectan en paralelo. La potencia suministrada está en función de la tensión de alimentación, para definir la carga se puede considerar una absorción de 3,6 V por LED alimentado. El cableado aguas abajo de los convertidores se debe hacer en serie, además es necesario efectuar el cableado de los aparatos y solamente tras haberlo completado suministrar alimentación al controlador.

Wiring Diagram

Schema di cablaggio - Schéma de câblage

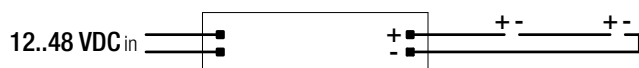

Schaltplan - Diagrama de cableado



350 mA

	AL7021	Potenza Power Puissance Bestuekung Potencia	V in	I out	Dimensioni Dimensions Größe Dimensiones
	IP20	16 W	12..48 VDC	350 mA	57x19x16 (h)

500 mA

	AL7022	Potenza Power Puissance Bestuekung Potencia	V in	I out	Dimensioni Dimensions Größe Dimensiones
	IP20	22,5 W	12..48 VDC	500 mA	57x19x16 (h)



24VDC RGB Driver/Controller

Sistemi di alimentazione e controllo RGB 24VDC

Systèmes d'alimentation et de contrôle RGB 24VDC

RGB Konstanspannung-Speisungs- und Steuerungssysteme 24VDC

Sistemas de alimentación y control RGB 24VDC

The systems provide a single power and control device for RGB 24VDC luminaires. Prepared to be managed via a button that is normally open, you can also manage the control via remote control using the appropriate accessories.

I sistemi offrono in un singolo apparato alimentazione e controllo per apparecchi RGB a 24VDC. Predisposti per gestione tramite pulsante normalmente aperto, è possibile gestire il controllo anche tramite telecomando utilizzando gli appositi accessori.

Les systèmes offrent, dans un seul appareillage, l'alimentation et le contrôle pour appareils RGB à 24VDC. Prêdisposés pour gestion via un bouton normalement ouvert, il est également possible de gérer le contrôle via télécommande à l'aide des accessoires spéciaux.

Diese Systeme bieten in einem einzigen Gerät die Speisung und die Steuerung der RGB Geräte mit 24 VDC. Vorbereitet zur Steuerung mit normalerweise offenen Tastern, mithilfe des entsprechenden Zubehörs, ist auch die Steuerung mit Fernbedienung möglich.

Los sistemas ofrecen en un solo aparato alimentación y control para aparatos RGB a 24VDC. Preparados para gestión mediante botón normalmente abierto, es posible gestionar el control también a través de mando a distancia utilizando los accesorios correspondientes.



C01011



IP20

Potenza
Power
Puissance
Bestuekung
Potencia

55 W

Dimensioni
Dimensions
Größe
Dimensiones

147x75x39 (h)

Sincronizzabili
Synchronizable
Synchronisable
Synchronisierbar
Sncronizable

max 10 drivers

Optionals

Accessori - Accessoires
Zubehör - Accesorios

C01040

Remote control

Telecomando
Télécommande
Fernsteuerung
Mando a distancia

C01041

IR receiver

Sensore IR
Récepteur IR
IR-Empfänger
Receptor IR

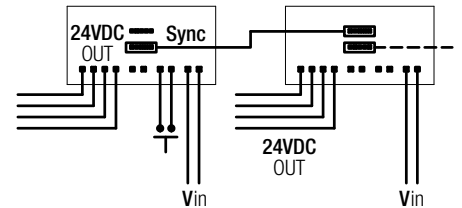
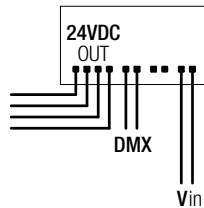
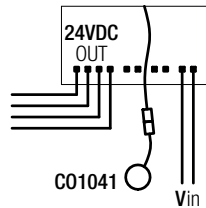
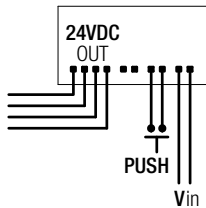

C01021



IP20

Potenza
Power
Puissance
Bestuekung
Potencia

120 W

Dimensioni
Dimensions
Größe
Dimensiones

225x61x49 (h)

Sincronizzabili
Synchronizable
Synchronisable
Synchronisierbar
Sncronizable

max 10 drivers

Optionals

Accessori - Accessoires
Zubehör - Accesorios

C01050

Remote control

Telecomando
Télécommande
Fernsteuerung
Mando a distancia

C01051

IR receiver

Sensore IR
Récepteur IR
IR-Empfänger
Receptor IR

C01051

Synchronization cable 2mt

Cavetto di sincronizzazione 2mt
Câble de synchronisation 2mt
Synchronisationskabel 2mt
Cable de sincronización 2mt

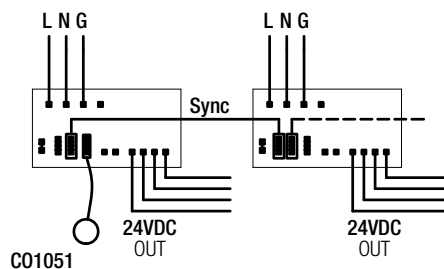
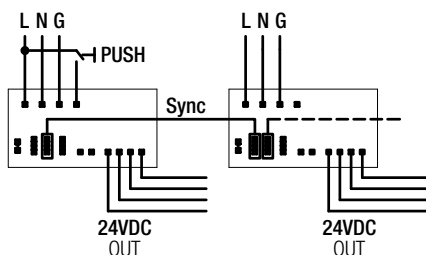

RGB 3x350mA Driver/Controller

Sistemi di alimentazione e controllo RGB in corrente costante 3x350 mA
 Systèmes d'alimentation et de contrôle RGB en courant constant 3x350 mA
 RGB Konstantstrom-Speisungs- und Steuerungssysteme 3x350 mA
 Sistemas de alimentación y control RGB en corriente constante 3x350 mA

The systems provide single power and control equipment for RGB 3x350 mA luminaires. Prepared to be managed via a button that is normally open, you can also manage the control via remote control using the appropriate accessories. The wiring of the luminaires is standard. It is necessary to make a wiring harness for the luminaires and supply power to the driver only after completing it.

I sistemi offrono in un singolo apparato alimentazione e controllo per apparecchi RGB 3x350 mA. Predisposti per gestione tramite pulsante normalmente aperto, è possibile gestire il controllo anche tramite telecomando utilizzando gli appositi accessori. Il cablaggio degli apparecchi è in serie. È necessario effettuare il cablaggio degli apparecchi e solamente dopo averlo completato fornire alimentazione al driver.

Les systèmes offrent, dans un seul appareillage, l'alimentation et le contrôle pour appareils RGB 3x350 mA. Prêdisposés pour gestion via un bouton normalement ouvert, il est également possible de gérer le contrôle via télécommande à l'aide des accessoires spéciaux. Le câblage des appareils est en série. Il faut effectuer le câblage des appareils et seulement après l'avoir complété, fournir l'alimentation au driver.

Diese Systeme bieten in einem einzigen Gerät die Speisung und die Steuerung der RGB Geräte 3x350 mA. Vorbereitet zur Steuerung mit normalerweise offenen Tastern, mithilfe des entsprechenden Zubehörs, ist auch die Steuerung mit Fernbedienung möglich. Die Verkabelung der Geräte wird in Reihe geschaltet. Man muss zuerst die Geräte verkabeln und nur nach Abschluss der Arbeiten kann man den Driver speisen.

Los sistemas ofrecen en un solo aparato alimentación y control para aparatos RGB 3x350 mA. Preparados para gestión mediante botón normalmente abierto, es posible gestionar el control también a través de mando a distancia utilizando los accesorios correspondientes. El cableado de los aparatos es en serie. Es necesario efectuar el cableado de los aparatos y solamente tras haberlo completado suministrar alimentación al controlador.



C03010

min 2 - max 9
LED RGB



Potenza
Power
Puissance
Bestuekung
Potencia

27 W

Dimensioni
Dimensions
Größe
Dimensiones

147x75x39 (h)

Sincronizzabili
Synchronizable
Synchronisable
Synchronisierbar
Snchronizable

max 10 drivers

Optionals

Accessori - Accessoires
Zubehör - Accesorios

C01040

Remote control

Telecomando
Télécommande
Fernsteuerung
Mando a distancia

C02012

IR receiver

Sensore IR
Récepteur IR
IR-Empfänger
Receptor IR

