

VIGO ROUND LED
RECESSED ADJUSTABLE DOWNLIGHT
DLD/1021114IL

DLD
CONTRACT

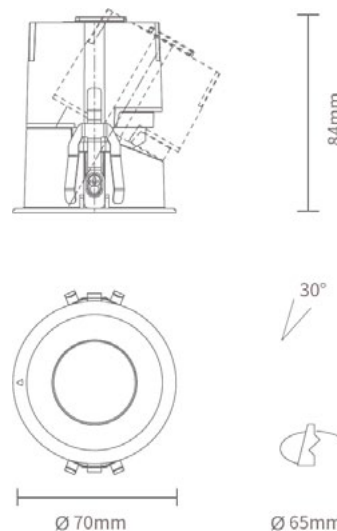

Dimensions
Ø70mm, H.84mm

Tilt
30°

Cutout
Ø65mm

- IP20
- 10W CREE LED COB (chip on board)
- Beam angle: 15° | 25° | 36° | 54°
- Ø65mm round cutout
- 30° adjustable tilt
- 35° glare cut
- 0.27kg weight
- Driver included - non-dim | 1-10V | TRIAC | DALI



VIGO ROUND LED
RECESSED ADJUSTABLE DOWNLIGHT
DLD/1021114IL



OVERVIEW

Power	Beam	Flux	CCT	Non-dim	1-10V dim	TRIAC dim	DALI dim
10W	15°	393lm	2700K	Y	Y	Y	Y
10W	15°	440lm	3000K	Y	Y	Y	Y
10W	15°	492lm	4000K	Y	Y	Y	Y
10W	26°	552lm	2700K	Y	Y	Y	Y
10W	26°	598lm	3000K	Y	Y	Y	Y
10W	26°	599lm	4000K	Y	Y	Y	Y
10W	36°	605lm	2700K	Y	Y	Y	Y
10W	36°	639lm	3000K	Y	Y	Y	Y
10W	36°	665lm	4000K	Y	Y	Y	Y
10W	54°	509lm	2700K	Y	Y	Y	Y
10W	54°	524lm	3000K	Y	Y	Y	Y
10W	54°	532lm	4000K	Y	Y	Y	Y

LUMINOUS DISTRIBUTION DIAGRAM - 10W

15°

CRI >90
 Output V 12V DC
 Input I 700mA

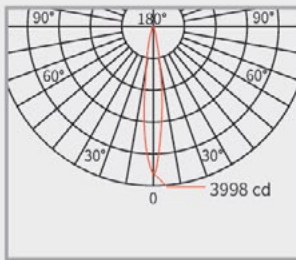

2700K		
h(m)	Ø(m)	LUX(Center/avg)
2	0.53	911/625
3	0.79	405/278
4	1.06	228/156

3000K		
h(m)	Ø(m)	LUX(Center/avg)
2	0.54	1000/689
3	0.81	444/306
4	1.08	250/172

4000K		
h(m)	Ø(m)	LUX(Center/avg)
2	0.52	1156/765
3	0.78	514/340
4	1.05	289/191

26°

CRI >90
 Output V 36V DC
 Input I 250mA

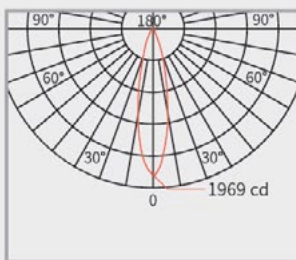

2700K		
h(m)	Ø(m)	LUX(Center/avg)
2	0.97	459/314
3	1.46	204/139
4	1.94	115/78

3000K		
h(m)	Ø(m)	LUX(Center/avg)
2	0.98	492/338
3	1.48	219/150
4	1.97	123/85

4000K		
h(m)	Ø(m)	LUX(Center/avg)
2	0.99	480/332
3	1.49	213/148
4	1.98	120/83

36°

CRI >90
 Output V 36V DC
 Input I 250mA

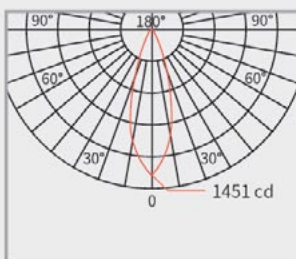

2700K		
h(m)	Ø(m)	LUX(Center/avg)
2	1.29	349/235
3	1.94	155/105
4	2.59	87/59

3000K		
h(m)	Ø(m)	LUX(Center/avg)
2	1.29	363/244
3	1.94	161/109
4	2.58	91/61

4000K		
h(m)	Ø(m)	LUX(Center/avg)
2	1.30	379/245
3	1.95	168/109
4	2.60	95/61

54°

CRI >90
 Output V 36V DC
 Input I 250mA

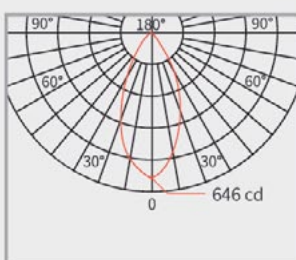

2700K		
h(m)	Ø(m)	LUX(Center/avg)
2	2.05	160/96
3	3.07	71/43
4	4.09	40/24

3000K		
h(m)	Ø(m)	LUX(Center/avg)
2	2.08	161/98
3	3.12	72/44
4	4.16	40/25

4000K		
h(m)	Ø(m)	LUX(Center/avg)
2	2.12	161/100
3	3.18	72/44
4	4.24	40/25

VIGO ROUND LED
RECESSED ADJUSTABLE DOWNLIGHT
DLD/1021114IL



BEZEL / BAFFLE FINISH



White bezel / Black baffle



White bezel / White baffle



Black bezel / Black baffle

BEAM ANGLE

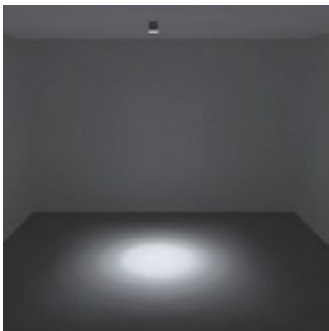

15°



26°

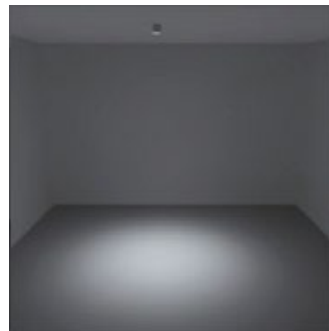

36°

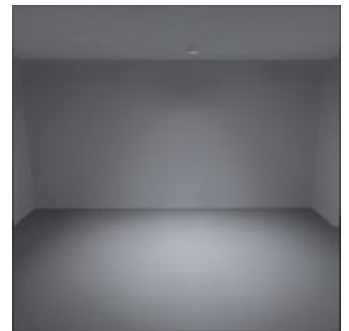

54°

LENS

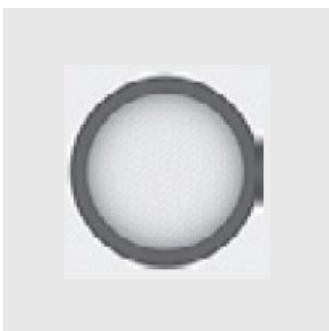

Tensile lens



Soft lens



Honeycomb louvre

PRODUCT CODE CONSTRUCTION

VIGO ROUND LED RECESSED ADJUSTABLE DOWNLIGHT

DLD/1021114IL / [X] / [X] / [X] / [X] / [X] / [X] / [X]

CONTROL:

[NON] [1/10V] [TRI] [DAL]
NON-DIM 1-10V DIM TRIAC DIM DALI DIM

LENS:

[TNL] [SFL] [HL]
Tensile Lens Soft Lens Honeycomb louvre

LIGHT COLOUR TEMPERATURE (CCT):

[27K] [30K] [40K]
2700°K 3000°K 4000°K

BEAM ANGLE:

[15D] [26D] [36D] [54D]
15° 26° 36° 54°

WATTAGE:

[10W]
10W

BAFFLE FINISH:

[WH] [BK]
White Black

BEZEL FINISH:

[WH] [BK]
White Black

01189 889414

enquiries@dld-contract.co.uk

dld-contract.co.uk

DLD Contract Ltd
Unit 9 Brookside Nurseries
Church Road
Swallowfield
Reading
Berkshire
RG7 1TH