

TECHNICAL DATA SHEET

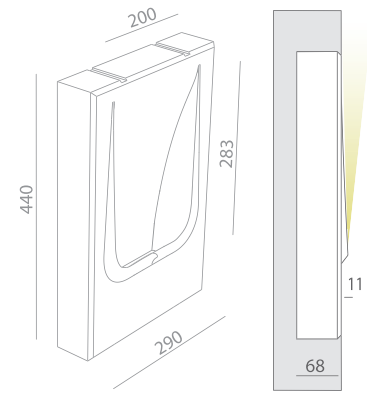

Ready for installation in solid walls
Optional plasterkit for installation into gypsum walls







PLASTERKIT MOVE OUT

REF N° 722 01 000 For mounting into gypsum walls

 295x445 mm. Housing: perforated aluminium







MOVE OUT HAL

REF N° 121 01 040

 QT14 - max 40W - G9
230V/50Hz  -  -  -  - 
IP20 - 850°C dimmable - 

MOVE OUT LED 600LM 230 VAC

REF N° 121 71 500 phase DIM CRI 80 2200°K
REF N° 121 71 000 phase DIM CRI 90 2700°K
REF N° 121 71 100 phase DIM CRI 90 3000°K
REF N° 121 31 500 DIM DALI CRI 80 2200°K
REF N° 121 31 000 DIM DALI CRI 90 2700°K
REF N° 121 31 100 DIM DALI CRI 90 3000°K

230V/50Hz - 6,5W - incl. line voltage LED driver
600lm@85°C - 700lm@25°C -  -  - IP20
parallel wiring  -  - 850°C  
Integrated line voltage LED driver
Connects directly to 230 VAC
2 SDCM - 2 Step MacAdam

