



# TECHNICAL DATA SHEET

## REMOTE LED DRIVER DIM







**REF N° 697 60 040** DIM 1-10V DALI PUSH 30W

230V/50Hz -  - current controlled  
 -  - IP20 - 250mA/350mA

## PIXO 30 LED 450LM CRI 97 230VAC

**REF N° 273 71 930** phase DIM CRI 97 2700°K







**REF N° 273 71 830** phase DIM CRI 97 3000°K

230V/50Hz - 6,5W - 32° beam angle  
 450lm@85°C - 500lm@25°C -  -  - IP20  
 parallel wiring  -  - 850°C    
 Connects directly to 230VAC - 2 SDCM  
 h=98 -  114x134 mm

## PIXO 30 LED 450LM CRI 97 REMOTE DRIVER

**REF N° 273 29 930** excl. LED driver CRI 97 2700°K

**REF N° 273 29 830** excl. LED driver CRI 97 3000°K







6,5W - excl. LED driver - 32° beam angle  
 450lm@85°C - 500lm@25°C -  -  - IP20  
 serial wiring  -  - 850°C    
 Requires remote LED driver - 2 SDCM  
 h=98 -  114x134 mm

## PIXO 30 LED 600LM 230VAC

**REF N° 273 71 530** phase DIM CRI 80 2200°K

**REF N° 273 71 030** phase DIM CRI 90 2700°K

**REF N° 273 71 130** phase DIM CRI 90 3000°K







230V/50Hz - 6,5W - 32° beam angle  
 600lm@85°C - 700lm@25°C -  -  - IP20  
 parallel wiring  -  - 850°C    
 Connects directly to 230VAC - 2 SDCM  
 h=98 -  114x134 mm

## PIXO 30 LED 600LM REMOTE DRIVER

**REF N° 273 29 530** excl. LED driver CRI 80 2200°K

**REF N° 273 29 030** excl. LED driver CRI 90 2700°K

**REF N° 273 29 130** excl. LED driver CRI 90 3000°K







6,5W - excl. LED driver - 32° beam angle  
 600lm@85°C - 700lm@25°C -  -  - IP20  
 serial wiring  -  - 850°C    
 Requires remote LED driver - 2 SDCM  
 h=98 -  114x134 mm

## PIXO 30 LED 150LM REAL SPOT 230VAC

**REF N° 273 70 510** phase DIM CRI 80 2200°K

**REF N° 273 70 010** phase DIM CRI 90 2700°K

**REF N° 273 70 110** phase DIM CRI 90 3000°K







230V/50Hz - 2W - 5° beam angle  
 140lm@85°C - 160lm@25°C -  -  - IP20  
 parallel wiring  -  - 850°C    
 Connects directly to 230VAC - 3 SDCM  
 h=98 -  114x134 mm

## PIXO 30 LED 150LM REAL SPOT REMOTE DRIVER

**REF N° 273 29 510** excl. LED driver CRI 80 2200°K

**REF N° 273 29 010** excl. LED driver CRI 90 2700°K

**REF N° 273 29 110** excl. LED driver CRI 90 3000°K

2W - excl. LED driver - 5° beam angle  
 140lm@85°C - 160lm@25°C -  -  - IP20  
 serial wiring  -  - 850°C    
 Requires remote LED driver - 3 SDCM  
 h=98 -  114x134 mm

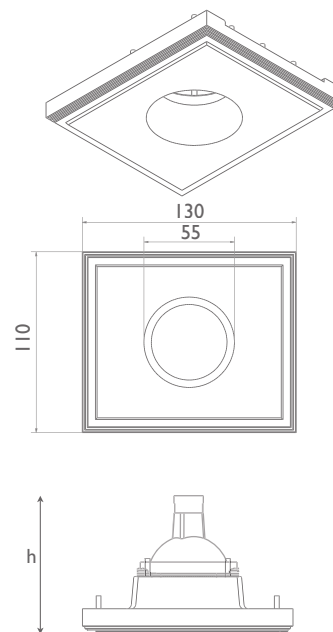

Included: installation system for gypsum ceiling 9 - 12 - 15 mm

## OPTIONAL INSTALLATION KIT

- REF N° 273 99 025** installation system for gypsum ceiling 25 mm
- REF N° 273 99 030** installation system for gypsum ceiling 30 mm
- REF N° 204 30 040** alternative lens for 30 series - beam angle 40°
- REF N° 204 30 050** alternative lens for 30 series - beam angle 50°
- REF N° 827 00 000** Concrete box Pixo 30/50 - Galvanized steel

